



南京时恒电子科技有限公司

规格承认书

APPROVAL SHEET

客户名称:

CUSTOMER _____

产品名称:

PART NAME 片式NTC热敏电阻规格书

产品规格:

PART NUMBER CMFX 1034F3950

日期:

DATE 2021年3月26日

确 认

CONFIRM

客户	供货商/制造商
品保部: _____	规格书制作: <u>鞠晓丽</u>
制造部: _____	业务员审核: _____
工程部: _____	技术部审核: <u>程鹏</u>
	品质部审核: <u>李少媛</u>

南京时恒电子科技有限公司

地址: 南京市江宁区湖熟镇金阳路18号 邮编: 211121

TEL: 025-52121868

FAX: 025-52122373

Http:// www.shiheng.com.cn

E-MAILsales@shiheng.com.cn



1 外形尺寸 Shape and Dimensions

- 尺寸: 见图 1 和表 1
- PCB 焊盘: 见图 2 和表 1
- Dimensions: See Fig.1 and Table 1.
- Recommended PCB pattern for reflow soldering: See Fig.2 and Table 1



图 1 Fig.1



图 2 Fig.2

表 1 (Table 1)

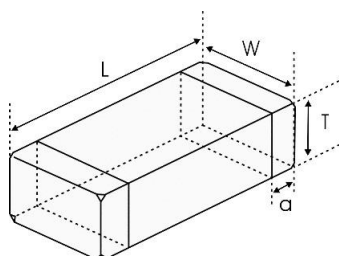
单位 unit: inch[mm]

类别Type	L	W	T	a	A	B	C
X [0402]	0.039±0.006 [1.0±0.15]	0.020±0.006 [0.5±0.15]	0.020±0.006 [0.5±0.15]	0.010±0.004 [0.25±0.1]	[0.45-0.55]	[0.4-0.5]	[0.45-0.55]

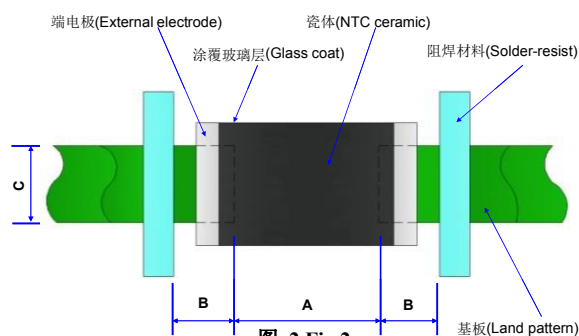
2 产品标识 (料号) Product Identification(Part Number)

CMF X 104 F 3950
 ① ② ③ ④ ⑤

① 类别 Type	
CMF	片式NTC 热敏电阻器 Chip NTC Thermistor

② 外形尺寸(mm) External Dimensions (L×W×T)	
0201[A]	0.60×0.3 0×0.3 0
X[0402]	1.00×0.5 0×0.5 0
A[0603]	1.60×0.8 0×0.8 0
B[0805]	2.00×1.2 5×0.8 5

③ 25℃的零功率电阻 Nominal Zero-Power Resistance	
502	5kΩ
683	68kΩ
④ 电阻值公差 Tolerance of Resistance	
F	±1%
G	±2%
H	±3%
J	±5%

⑤ B 值常数 B Constant	
3450	3450K
3950	3950K
4250	4250K

3 电气特性 Electrical Characteristics

型号 Part No	电阻值 Resistance (25℃) (kΩ)	B 常数B Constant (25/50℃) (K)	B 常数B Constant (25/85℃) (K)	允许工作电流 Permissible Operating Current (25℃) (mA)	耗散系数 Dissipation Factor (mW/℃)	热时间常数 Thermal Time Constant (s)	额定功率 Rated Electric Power(25℃) (mW)	工作温度 Operating ambient temperature (℃)
CMFX 104F3950	100±1%	3950±1%	4010	0.10	1.0	<3	100	-40~+125

4 检验和测试程序

测试条件

如无特别规定，检验和测试的标准大气环境条件如下：

- 环境温度：20±15℃；
- 相对湿度：65±20%；
- 气压：86 kPa~106 kPa

如果对测试结果有异议，则在下述条件下测试：

- 环境温度：25±2℃；
- 相对湿度：65±5%；
- 气压：86kPa ~ 106kPa

检查设备

外观检查：20 倍放大镜；

阻值检查：热敏电阻测试仪

4 Test and Measurement Procedures

Test Conditions

Unless otherwise specified, the standard atmospheric conditions for measurement/test as:

- Ambient Temperature: 20±15℃
- Relative Humidity: 65±20%
- Air Pressure: 86kPa to 106kPa

If any doubt on the results, measurements/tests should be made within the following limits:

- Ambient Temperature: 25±2℃
- Relative Humidity: 65±5%
- Air Pressure: 86kPa to 106kPa

Inspection Equipment

Visual Examination: 20× magnifier

Resistance value test: Thermistor resistance tester

5 电性测试 Electrical Test

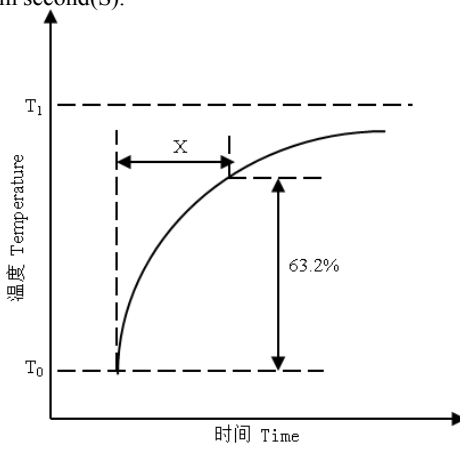
序号 No.	项目 Items	测试方法及备注 Test Methods and Remarks
1	25℃零功率电阻值 Nominal Zero-Power Resistance at 25℃(R25)	环境温度Ambient temperature: 25±0.05℃ 测试功率Measuring electric power: ≤0.1mW
2	B 值常数 Nominal B Constant	分别在环境温度 25±0.05℃, 50±0.05℃或 85±0.05℃下测量电阻值。 Measure the resistance at the ambient temperature of 25±0.05℃, 50±0.05℃ or 85±0.05℃. $B(25-50^{\circ}\text{C}) = \frac{\ln R_{25} - \ln R_{50}}{1/T_{25} - 1/T_{50}} \quad B(25-85^{\circ}\text{C}) = \frac{\ln R_{25} - \ln R_{85}}{1/T_{25} - 1/T_{85}}$ T: 绝对温度 (K) Absolute temperature (K)
3	热时间常数 Thermal Time Constant	<p>在零功率条件下，当热敏电阻的环境温度发生急剧变化时，热敏电阻元件产生最初温度 T₀ 与最终温度 T₁ 两者温度差的 63.2% 的温度变化所需要的时间，通常以秒(S)表示。</p> <p>The total time for the temperature of the thermistor to change by 63.2% of the difference from ambient temperature T₀ (°C) to T₁ (°C) by the drastic change of the power applied to thermistor from Non-zero Power to Zero-Power state, normally expressed in second(S).</p> 

4	耗散系数 Dissipation Factor	在一定环境温度下，NTC 热敏电阻通过自身发热使其温度升高 1℃时所需要的功率，通常以mW/℃表示。可由下面公式计算： The required power which makes the NTC thermistor body temperature raise 1℃ through self-heated, normally expressed in milliwatts per degree Celsius (mW/℃). It can be calculated by the following formula: $\delta = \frac{W}{T-T_0}$
5	额定功率 Rated Power	在环境温度 25℃下因自身发热使表面温度升高 100℃所需要的功率。The necessary electric power makes thermistor's temperature rise 100℃ by self-heating at ambient temperature 25℃.
6	允许工作电流 Permissible operating current	在静止空气中通过自身发热使其升温为 1℃的电流。 The current that keep body temperature of chip NTC on the PC board in still air rising 1℃by self-heating.

6 信赖性试验 Reliability Test

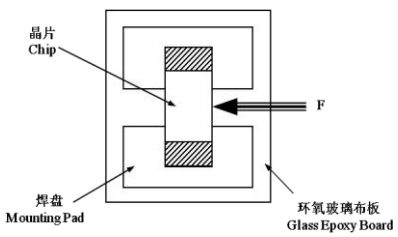
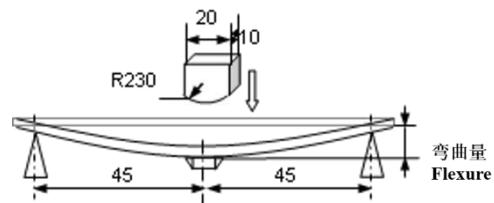
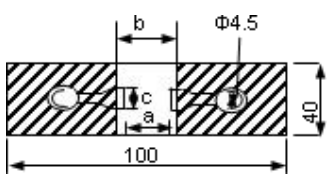
项目 Items	测试标准 Standard	测试方法及备注 Test Methods and Remarks	要求 Requirements																														
端头附着力 Terminal Strength	IEC 60068-2-21	<p>将晶片焊接在测试基板上（如右图所示的环氧玻璃布板），按箭头所示方向施加作用力； Solder the chip to the testing jig (glass epoxy board shown in the right) using eutectic solder. Then apply a force in the direction of the arrow.</p> <table border="1"> <thead> <tr> <th>尺寸 Size</th> <th>F</th> <th>保持时间 Duration</th> </tr> </thead> <tbody> <tr> <td>0201</td> <td>2N</td> <td rowspan="3">10±1s</td> </tr> <tr> <td>X, A</td> <td>5N</td> </tr> <tr> <td>B</td> <td>10N</td> </tr> </tbody> </table>	尺寸 Size	F	保持时间 Duration	0201	2N	10±1s	X, A	5N	B	10N	<p>端电极无脱落且瓷体无损伤。 No removal or split of the termination or other defects shall occur.</p> 																				
尺寸 Size	F	保持时间 Duration																															
0201	2N	10±1s																															
X, A	5N																																
B	10N																																
抗弯强度 Resistance to Flexure	IEC 60068-2-21	<p>将晶片焊接在测试基板上（如右图所示的环氧玻璃布板），按下图箭头所示方向施加作用力； Solder the chip to the test jig (glass epoxy board shown in the right) using a eutectic solder. Then apply a force in the direction shown as follow;</p>  <table border="1"> <thead> <tr> <th>尺寸 Size</th> <th>弯曲变形量 Flexure</th> <th>施压速度 Pressurizing Speed</th> <th>保持时间 Duration</th> </tr> </thead> <tbody> <tr> <td>0201,</td> <td>1mm</td> <td rowspan="2"><0.5mm/s</td> <td rowspan="2">10±1s</td> </tr> <tr> <td>X, A, B</td> <td>2mm</td> </tr> </tbody> </table>	尺寸 Size	弯曲变形量 Flexure	施压速度 Pressurizing Speed	保持时间 Duration	0201,	1mm	<0.5mm/s	10±1s	X, A, B	2mm	<p>① 无外观损伤。 No visible damage. ② $\Delta R_{25}/R_{25} \leq 2\%$</p> <p>单位 unit: mm</p> <table border="1"> <thead> <tr> <th>类型 Type</th> <th>a</th> <th>b</th> <th>c</th> </tr> </thead> <tbody> <tr> <td>0201</td> <td>0.25</td> <td>0.3</td> <td>0.3</td> </tr> <tr> <td>X</td> <td>0.4</td> <td>1.5</td> <td>0.5</td> </tr> <tr> <td>A</td> <td>1.0</td> <td>3.0</td> <td>1.2</td> </tr> <tr> <td>B</td> <td>1.2</td> <td>4.0</td> <td>1.65</td> </tr> </tbody> </table> 	类型 Type	a	b	c	0201	0.25	0.3	0.3	X	0.4	1.5	0.5	A	1.0	3.0	1.2	B	1.2	4.0	1.65
尺寸 Size	弯曲变形量 Flexure	施压速度 Pressurizing Speed	保持时间 Duration																														
0201,	1mm	<0.5mm/s	10±1s																														
X, A, B	2mm																																
类型 Type	a	b	c																														
0201	0.25	0.3	0.3																														
X	0.4	1.5	0.5																														
A	1.0	3.0	1.2																														
B	1.2	4.0	1.65																														

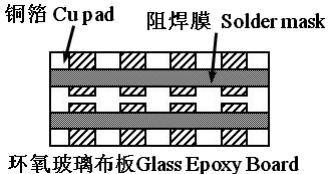
振动 Vibration	IEC 60068-2-80	① 将晶片焊接在测试基板上（如右图所示的环氧玻璃布板）； Solder the chip to the testing jig (glass epoxy board shown in the left) using eutectic solder. ② 晶片以全振幅为 1.5mm 进行振动，频率范围为 10Hz ~55 Hz； The chip shall be subjected to a simple harmonic motion having total amplitude of 1.5mm, the frequency being varied uniformly between the approximate limits of 10 and 55 Hz. ③ 振动频率按 10Hz→55Hz→10Hz 循环，周期为 1 分钟，在空间三个互相垂直的方向上各振动 2 小时（共 6 小时）。 The frequency ranges from 10 to 55 Hz and return to 10 Hz shall be traversed in approximately 1 minute. This motion shall be applied for a period of 2 hours in each 3 mutually perpendicular directions (total of 6 hours).	无外观损伤。 No visible damage. 															
坠落 Dropping	IEC 60068-2-32	从 1m 的高度让晶片自由坠落至水泥地面 10 次。 Drop a chip 10 times on a concrete floor from a height of 1 meter.	无外观损伤。 No visible damage.															
可焊性 Solderability	IEC 60068-2-58	① 焊接温度 Solder temperature: 245±5 °C. ② 浸渍时间 Duration: 3±0.3s. ③ 焊锡成分 Solder: 96.5Sn/3.0Ag/0.5Cu. ④ 助焊剂 Flux: (重量比) 25%松香和 75%酒精 25% Resin and 75% ethanol in weight.	① 无外观损伤； No visible damage. ② 元件端电极的焊锡覆盖率不小于 95%。 Wetting shall exceed 95% coverage.															
耐焊性 Resistance to Soldering Heat	IEC 60068-2-58	① 焊接温度 Solder temperature: 260±5 °C. ② 浸渍时间 Duration: 10±1s. ③ 焊锡成分 Solder: 96.5Sn/3.0Ag/0.5Cu. ④ 助焊剂 Flux: (重量比) 25%松香和 75%酒精 25% Resin and 75% ethanol in weight. ⑤ 试验后标准条件下放置 1~2 小时后测量。 The chip shall be stabilized at normal condition for 1~2 hours before measuring.	① 无外观损伤； No visible damage. ② $ \Delta R_{25}/R_{25} \leq 2\%$ ③ $ \Delta B/B \leq 1\%$															
温度周期 Temperature cycling	IEC 60068-2-14	① 无负载于下表所示的环境条件下重复 5 次。 5 cycles of following sequence without loading. <table border="1" data-bbox="491 1429 1040 1621"> <thead> <tr> <th>步骤 Step</th> <th>温度 Temperature</th> <th>时间 Time</th> </tr> </thead> <tbody> <tr> <td>1</td> <td>-40±5 °C</td> <td>30±3min</td> </tr> <tr> <td>2</td> <td>25±2 °C</td> <td>5±3min</td> </tr> <tr> <td>3</td> <td>125±2 °C</td> <td>30±3min</td> </tr> <tr> <td>4</td> <td>25±2 °C</td> <td>5±3min</td> </tr> </tbody> </table> ② 试验后标准条件下放置 1~2 小时后测量。 The chip shall be stabilized at normal condition for 1~2 hours before measuring.	步骤 Step	温度 Temperature	时间 Time	1	-40±5 °C	30±3min	2	25±2 °C	5±3min	3	125±2 °C	30±3min	4	25±2 °C	5±3min	① 无外观损伤； No visible damage. ② $ \Delta R_{25}/R_{25} \leq 2\%$ ③ $ \Delta B/B \leq 1\%$
步骤 Step	温度 Temperature	时间 Time																
1	-40±5 °C	30±3min																
2	25±2 °C	5±3min																
3	125±2 °C	30±3min																
4	25±2 °C	5±3min																
高温存放 Resistance to dry heat	IEC 60068-2-2	① 在 125±5 °C 空气中，无负载放置 1000±24 小时。 125±5 °C in air, for 1000±24 hours without loading. ② 试验后标准条件下放置 1~2 小时后测量。 The chip shall be stabilized at normal condition for 1~2 hours before measuring.	① 无外观损伤； No visible damage. ② $ \Delta R_{25}/R_{25} \leq 2\%$ ③ $ \Delta B/B \leq 1\%$															

低温存放 Resistance to cold	IEC 60068-2-1	① 在-40±3℃空气中, 无负载放置 1000±24 小时。 -40±3℃ in air, for 1000±24 hours without loading. ② 试验后标准条件下放置 1~2 小时后测量。 The chip shall be stabilized at normal condition for 1~2 hours before measuring.	① 无外观损伤; No visible damage. ② $ \Delta R25/R25 \leq 2\%$ ③ $ \Delta B/B \leq 1\%$
湿热存放 Resistance to damp heat	IEC 60068-2-78	① 在 40±2℃, 相对湿度 90~95%空气中, 无负载放置 1000±24 小时。 40±2℃, 90~95%RH in air, for 1000±24 hours without loading. ② 试验后标准条件下放置 1~2 小时后测量。 The chip shall be stabilized at normal condition for 1~2 hours before measuring.	① 无外观损伤; No visible damage. ② $ \Delta R25/R25 \leq 2\%$ ③ $ \Delta B/B \leq 1\%$
高温负荷 Resistance to high temperature load	IEC 60539-1 5.25.4	① 在 85±2℃空气中, 施加允许工作电流 1000±48 小时。 85±2℃ in air with permissive operating current for 1000±48 hours ② 试验后标准条件下放置 1~2 小时后测量。 The chip shall be stabilized at normal condition for 1~2 hours before measuring.	① 无外观损伤; No visible damage. ② $ \Delta R25/R25 \leq 2\%$ ③ $ \Delta B/B \leq 1\%$

7 编带 Taping

类型 Type	0201	X	A	B
编带厚度 Tape thickness(mm)	0.5±0.15	0.5±0.15	0.8±0.15	0.85±0.2
编带材质 Tape material	纸带 Paper Tape			
每盘数量 Quantity per Reel	15K	10K	4K	4K

(1) 编带图 Taping Drawings

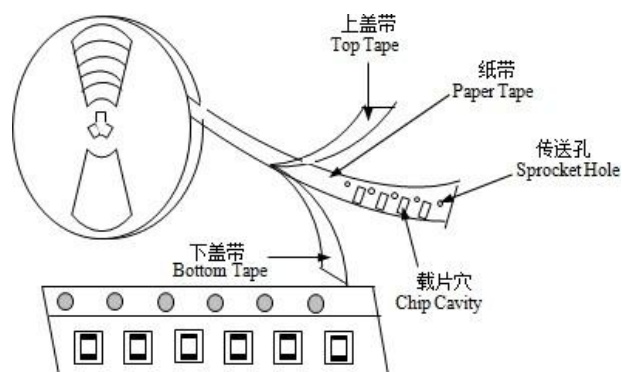

(2) 纸带尺寸 Paper Tape Dimensions (单位 Unit: mm)

CMF0201 系列 CMF0201 series

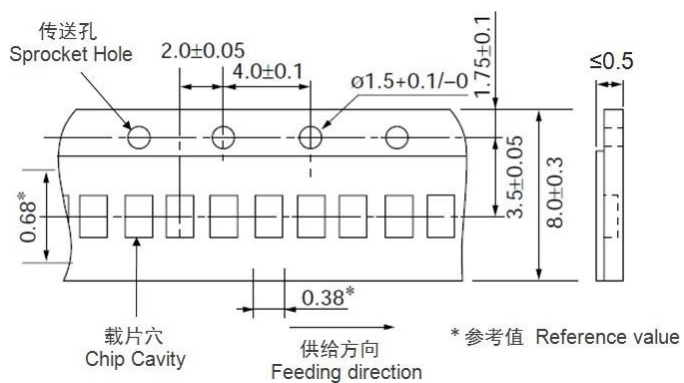

CMFX 系列 CMFX series

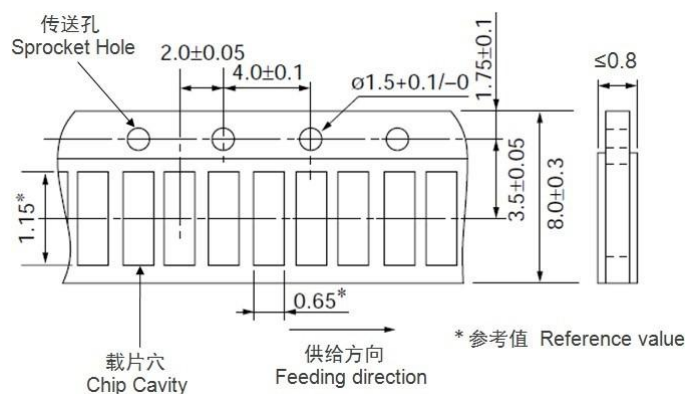

CMFA 系列 CMFA series

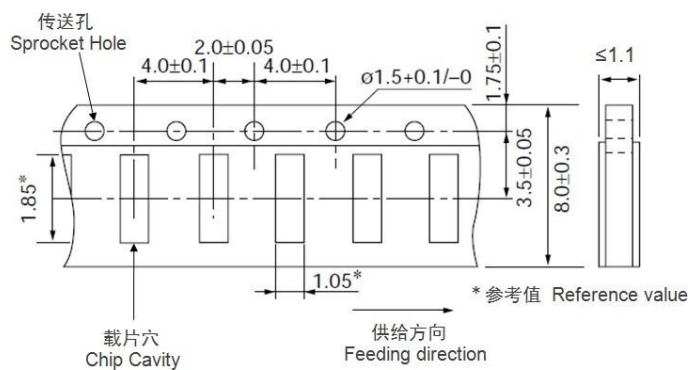

CMFB 系列 CMFB series

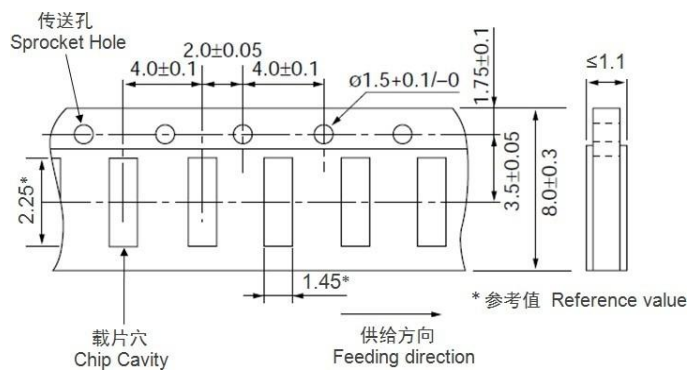

(3) 卷盘尺寸 Reel Dimensions (单位 Unit: mm)

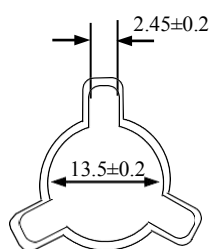
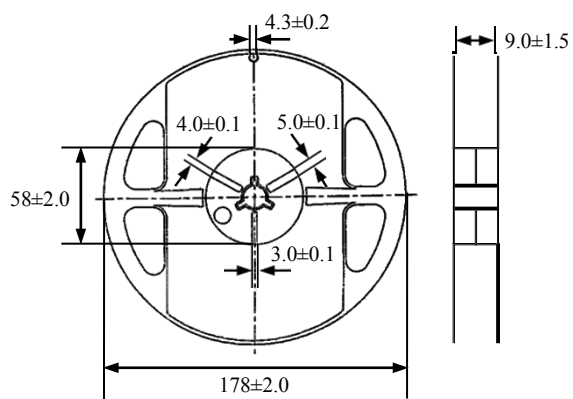

8 储存

• 储存条件

- a. 储存温度: $-10^{\circ}\text{C} \sim 40^{\circ}\text{C}$
- b. 相对湿度: $\leq 75\% \text{RH}$
- c. 避免接触粉尘、腐蚀性气氛和阳光

• 储存期限: 产品交付后 6 个月

9 注意事项

• CMF 系列热敏电阻不可在以下条件下工作或储存:

- (1) 腐蚀性气体或还原性气体
(氯气、硫化氢气体、氨气、硫酸气体、一氧化氮等)。
- (2) 挥发性或易燃性气体
- (3) 多尘条件
- (4) 高压或低压条件
- (5) 潮湿场所
- (6) 存在盐水、油、化学液体或有机溶剂的场所
- (7) 强烈振动
- (8) 存在类似有害条件的其他场所

• CMF 系列热敏电阻的陶瓷属于易碎材料, 使用时不可施加过大压力或冲击。

• CMF 系列热敏电阻不可在超过目录规定的温度范围情况下工作。

8 Storage

• Storage Conditions

- a. Storage Temperature: $-10^{\circ}\text{C} \sim 40^{\circ}\text{C}$
- b. Relative Humidity: $\leq 75\% \text{RH}$
- c. Keep away from corrosive atmosphere and sunlight.

• Period of Storage: 6 Months after delivery

9 Notes & Warnings

• The CMF series thermistors shall not be operated and stored under the following environmental condition:

- (1) Corrosive or deoxidized atmospheres
(such as chlorine, sulfurated hydrogen, ammonia, sulfuric acid, nitric oxide and so on)
- (2) Volatile or inflammable atmospheres
- (3) Dusty condition
- (4) Excessively high or low pressure condition
- (5) Humid site
- (6) Places with brine, oil, chemical liquid or organic solvent
- (7) Intense vibration
- (8) Places with analogously deleterious conditions

• The ceramic body of the CMF series thermistors is fragile, no excessive pressure or impact shall be exerted on it.

• The CMF series thermistors shall not be operated beyond the specified "Operating Temperature Range" in the catalog.

10 建议焊接条件

• 回流焊

温升 1~2°C/sec.

预热: 150~170°C/90±30 sec.

大于 240°C时间: 20~40sec

峰值温度: 最高 260°C/10 sec.

焊锡: 96.5Sn/3.0Ag/0.5Cu

回流焊: 最多 2 次

10 Recommended Soldering Technologies

• Re-flowing Profile

1~2°C/sec. Ramp

Pre-heating: 150~170°C/90±30 sec.

Time above 240°C: 20~40 sec.

Peak temperature: 260°C Max./10 sec.

Solder paste: 96.5Sn/3.0Ag/0.5Cu

Max.2 times for re-flowing

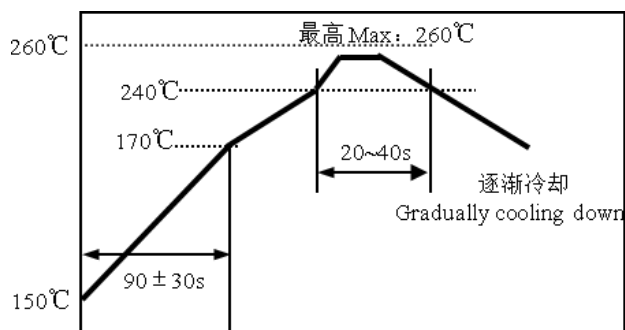

• 手工焊

烙铁功率: 最大 20W

预热: 150°C/60sec.

烙铁头温度: 最高 280°C

焊接时间: 最多 3sec.

焊锡: 96.5Sn/3.0Ag/0.5Cu

手工焊: 最多 1 次

• Iron Soldering Profile

Iron soldering power: Max.20W

Pre-heating: 150°C/60sec.

Soldering Tip temperature: 280°C Max.

Soldering time: 3 sec Max.

Solder paste: 96.5Sn/3.0Ag/0.5Cu

Max.1 times for iron soldering

[注: 不要使烙铁头接触到端头]

[Note: Take care not to apply the tip of the soldering iron to the terminal electrodes.]

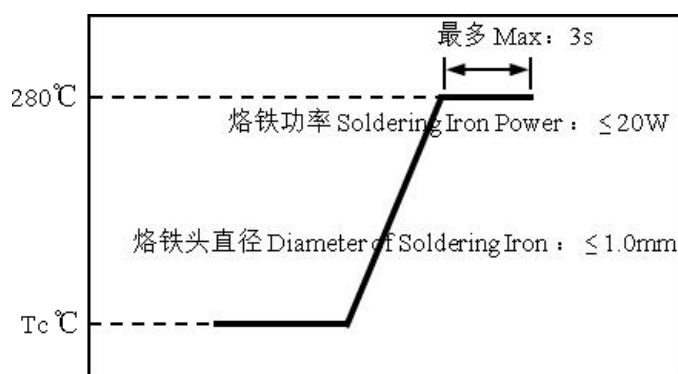

11 R-T 表 R-T table

CMFX 104F3950FB

温度 Temp. (°C)	R 最小值 R_Min (Kohm)	R 中心值 R_Cent (Kohm)	R 最大值 R_Max (Kohm)	阻值公差 Res TOL.	温度公差 Temp. TOL.(°C)
-40	3,084.269	3,225.545	3,372.955	4.57%	0.67
-39	2,892.785	3,023.332	3,159.454	4.50%	0.66
-38	2,714.318	2,834.987	2,960.724	4.44%	0.66
-37	2,547.912	2,659.483	2,775.662	4.37%	0.65
-36	2,392.685	2,495.874	2,603.252	4.30%	0.65
-35	2,247.826	2,343.289	2,442.561	4.24%	0.64
-34	2,112.585	2,200.924	2,292.728	4.17%	0.64
-33	1,986.272	2,068.041	2,152.960	4.11%	0.63
-32	1,868.248	1,943.955	2,022.527	4.04%	0.63
-31	1,757.924	1,828.036	1,900.755	3.98%	0.62
-30	1,654.757	1,719.704	1,787.021	3.91%	0.62
-29	1,558.243	1,618.419	1,680.751	3.85%	0.61
-28	1,467.918	1,523.686	1,581.415	3.79%	0.61
-27	1,383.351	1,435.046	1,488.524	3.73%	0.60
-26	1,304.144	1,352.073	1,401.624	3.66%	0.59
-25	1,229.928	1,274.376	1,320.298	3.60%	0.59
-24	1,160.363	1,201.590	1,244.157	3.54%	0.58
-23	1,095.132	1,133.379	1,172.844	3.48%	0.58
-22	1,033.942	1,069.430	1,106.026	3.42%	0.57
-21	976.520	1,009.455	1,043.396	3.36%	0.57
-20	922.616	953.185	984.670	3.30%	0.56
-19	871.994	900.373	929.583	3.24%	0.55
-18	824.437	850.787	877.890	3.19%	0.55
-17	779.744	804.212	829.365	3.13%	0.54
-16	737.728	760.451	783.797	3.07%	0.54
-15	698.212	719.319	740.990	3.01%	0.53
-14	661.037	680.643	700.761	2.96%	0.52
-13	626.050	644.265	662.943	2.90%	0.52
-12	593.112	610.035	627.379	2.84%	0.51
-11	562.091	577.816	593.921	2.79%	0.50
-10	532.867	547.478	562.435	2.73%	0.50
-9	505.325	518.903	532.793	2.68%	0.49
-8	479.360	491.979	504.879	2.62%	0.48
-7	454.874	466.601	478.582	2.57%	0.48
-6	431.775	442.674	453.801	2.51%	0.47
-5	409.977	420.105	430.441	2.46%	0.46
-4	389.400	398.813	408.412	2.41%	0.46
-3	369.970	378.717	387.631	2.35%	0.45
-2	351.616	359.744	368.023	2.30%	0.44
-1	334.274	341.826	349.514	2.25%	0.43
0	317.882	324.899	332.037	2.20%	0.43
1	302.384	308.903	315.530	2.15%	0.42

温度 Temp. (°C)	R 最小值 R_Min (Kohm)	R 中心值 R_Cent (Kohm)	R 最大值 R_Max (Kohm)	阻值公差 Res TOL.	温度公差 Temp. TOL.(°C)
2	287.726	293.781	299.934	2.09%	0.41
3	273.859	279.483	285.193	2.04%	0.41
4	260.735	265.958	271.258	1.99%	0.40
5	248.312	253.161	258.078	1.94%	0.39
6	236.548	241.049	245.611	1.89%	0.38
7	225.405	229.582	233.813	1.84%	0.38
8	214.847	218.722	222.645	1.79%	0.37
9	204.841	208.435	212.071	1.74%	0.36
10	195.354	198.687	202.056	1.70%	0.35
11	186.358	189.447	192.568	1.65%	0.34
12	177.824	180.686	183.576	1.60%	0.34
13	169.727	172.377	175.052	1.55%	0.33
14	162.041	164.495	166.969	1.50%	0.32
15	154.745	157.015	159.302	1.46%	0.31
16	147.816	149.914	152.028	1.41%	0.30
17	141.233	143.173	145.124	1.36%	0.30
18	134.979	136.770	138.571	1.32%	0.29
19	129.035	130.688	132.348	1.27%	0.28
20	123.384	124.908	126.437	1.22%	0.27
21	118.010	119.413	120.822	1.18%	0.26
22	112.898	114.190	115.485	1.13%	0.25
23	108.035	109.222	110.412	1.09%	0.25
24	103.406	104.497	105.588	1.04%	0.24
25	99.000	100.000	101.000	1.00%	0.23
26	94.722	95.720	96.720	1.04%	0.24
27	90.650	91.646	92.643	1.09%	0.25
28	86.775	87.766	88.760	1.13%	0.26
29	83.086	84.071	85.059	1.18%	0.27
30	79.572	80.550	81.532	1.22%	0.29
31	76.225	77.195	78.169	1.26%	0.30
32	73.036	73.997	74.962	1.30%	0.31
33	69.997	70.947	71.903	1.35%	0.32
34	67.100	68.039	68.985	1.39%	0.33
35	64.337	65.265	66.200	1.43%	0.35
36	61.703	62.618	63.541	1.47%	0.36
37	59.189	60.092	61.003	1.52%	0.37
38	56.791	57.681	58.579	1.56%	0.38
39	54.502	55.379	56.264	1.60%	0.40
40	52.317	53.180	54.052	1.64%	0.41
41	50.230	51.080	51.938	1.68%	0.42
42	48.237	49.073	49.918	1.72%	0.43
43	46.334	47.155	47.986	1.76%	0.45
44	44.515	45.321	46.138	1.80%	0.46
45	42.776	43.569	44.371	1.84%	0.47
46	41.114	41.892	42.681	1.88%	0.49

温度 Temp. (°C)	R 最小值 R_Min (Kohm)	R 中心值 R_Cent (Kohm)	R 最大值 R_Max (Kohm)	阻值公差 Res TOL.	温度公差 Temp. TOL.(°C)
47	39.525	40.289	41.063	1.92%	0.50
48	38.005	38.755	39.515	1.96%	0.51
49	36.551	37.286	38.033	2.00%	0.53
50	35.160	35.881	36.613	2.04%	0.54
51	33.829	34.536	35.254	2.08%	0.55
52	32.555	33.248	33.952	2.12%	0.57
53	31.335	32.014	32.704	2.16%	0.58
54	30.166	30.832	31.508	2.20%	0.59
55	29.047	29.699	30.362	2.23%	0.61
56	27.975	28.614	29.264	2.27%	0.62
57	26.948	27.573	28.210	2.31%	0.64
58	25.963	26.576	27.199	2.35%	0.65
59	25.020	25.619	26.230	2.38%	0.66
60	24.115	24.701	25.300	2.42%	0.68
61	23.247	23.821	24.407	2.46%	0.69
62	22.415	22.976	23.550	2.50%	0.71
63	21.616	22.166	22.727	2.53%	0.72
64	20.850	21.388	21.937	2.57%	0.73
65	20.114	20.641	21.179	2.61%	0.75
66	19.408	19.923	20.450	2.64%	0.76
67	18.731	19.234	19.749	2.68%	0.78
68	18.080	18.572	19.076	2.71%	0.79
69	17.454	17.936	18.430	2.75%	0.81
70	16.854	17.325	17.808	2.79%	0.82
71	16.277	16.738	17.210	2.82%	0.84
72	15.722	16.173	16.635	2.86%	0.85
73	15.189	15.630	16.082	2.89%	0.87
74	14.676	15.108	15.550	2.93%	0.88
75	14.184	14.605	15.038	2.96%	0.90
76	13.710	14.122	14.545	3.00%	0.91
77	13.254	13.657	14.071	3.03%	0.93
78	12.815	13.209	13.614	3.07%	0.95
79	12.393	12.779	13.175	3.10%	0.96
80	11.987	12.364	12.751	3.13%	0.98
81	11.596	11.965	12.344	3.17%	0.99
82	11.220	11.580	11.951	3.20%	1.01
83	10.857	11.210	11.572	3.23%	1.02
84	10.508	10.853	11.207	3.27%	1.04
85	10.172	10.509	10.856	3.30%	1.06
86	9.848	10.177	10.517	3.33%	1.07
87	9.536	9.858	10.190	3.37%	1.09
88	9.235	9.550	9.875	3.40%	1.10
89	8.945	9.253	9.571	3.43%	1.12
90	8.666	8.967	9.277	3.47%	1.14
91	8.396	8.691	8.995	3.50%	1.15

温度 Temp. (°C)	R 最小值 R_Min (Kohm)	R 中心值 R_Cent (Kohm)	R 最大值 R_Max (Kohm)	阻值公差 Res TOL.	温度公差 Temp. TOL.(°C)
92	8.136	8.424	8.722	3.53%	1.17
93	7.885	8.167	8.458	3.56%	1.19
94	7.644	7.919	8.204	3.59%	1.20
95	7.410	7.680	7.958	3.63%	1.22
96	7.185	7.449	7.721	3.66%	1.24
97	6.968	7.226	7.492	3.69%	1.25
98	6.758	7.010	7.271	3.72%	1.27
99	6.556	6.802	7.057	3.75%	1.29
100	6.360	6.601	6.851	3.78%	1.31
101	6.171	6.407	6.652	3.81%	1.32
102	5.989	6.220	6.459	3.84%	1.34
103	5.813	6.039	6.273	3.88%	1.36
104	5.643	5.864	6.093	3.91%	1.38
105	5.478	5.694	5.918	3.94%	1.39
106	5.319	5.531	5.750	3.97%	1.41
107	5.166	5.373	5.587	4.00%	1.43
108	5.017	5.220	5.430	4.03%	1.45
109	4.873	5.072	5.277	4.06%	1.46
110	4.735	4.929	5.130	4.09%	1.48
111	4.600	4.790	4.987	4.12%	1.50
112	4.470	4.656	4.849	4.15%	1.52
113	4.345	4.527	4.716	4.18%	1.54
114	4.223	4.401	4.586	4.20%	1.56
115	4.105	4.280	4.461	4.23%	1.57
116	3.992	4.162	4.340	4.26%	1.59
117	3.881	4.048	4.222	4.29%	1.61
118	3.775	3.938	4.108	4.32%	1.63
119	3.671	3.831	3.998	4.35%	1.65
120	3.571	3.728	3.891	4.38%	1.67
121	3.474	3.628	3.788	4.41%	1.69
122	3.381	3.531	3.687	4.43%	1.70
123	3.290	3.437	3.590	4.46%	1.72
124	3.202	3.346	3.496	4.49%	1.74
125	3.116	3.257	3.405	4.52%	1.76