

## LM393B、LM2903B、LM193、LM293、LM393 和 LM2903 双路比较器

### 1 特性

- 新增了 LM393B 和 LM2903B
- 改进了 B 版本的规格
  - 最大额定值：高达 38V
  - ESD 等级 (HBM)：2kV
  - 低输入失调电压：0.37mV
  - 低输入偏置电流：3.5nA
  - 低电源电流：每个比较器 200 $\mu$ A
  - 更短的响应时间 (1 微秒)
  - LM393B 的工作温度范围
  - 采用 2 x 2mm 微型 WSON 封装
- B 版本可直接取代 LM293、LM393 和 LM2903 的 A 和 V 版本
- 共模输入电压范围包括接地
- 差分输入电压范围等于最大额定电源电压： $\pm 38V$
- 低输出饱和电压
- 输出与 TTL、MOS 和 CMOS 兼容

### 2 应用

- 扫地机器人
- 单相 UPS
- 服务器 PSU
- 无绳电动工具
- 无线基础设施
- 电器
- 楼宇自动化
- 工厂自动化与控制
- 电机驱动器
- 信息娱乐系统与仪表组

### 3 说明

LM393B 和 LM2903B 器件是业界通用 LM393 和 LM2903 比较器系列的下一代版本。下一代 B 版本比较器具有更低的失调电压、更高的电源电压能力、更低的电源电流、更低的输入偏置电流和更低的传播延迟，并通过专用 ESD 钳位提高了 2kV ESD 性能和输入耐用性。LM393B 和 LM2903B 可直接替代 LM293、LM393 和 LM2903 (“A” 和 “V” 版本)。

所有器件都包含两个独立的电压比较器，这些比较器可在宽电压范围内由单电源供电运行。静态电流不受电源电压的影响。

#### 器件信息

器件型号	封装 <sup>(1)</sup>	封装尺寸 (标称值)
LM393B、LM2903B、LM193、LM293、LM293A、LM393、LM393A、LM2903、LM2903V、LM2903AV	SOIC (8)	4.90mm x 3.91mm
LM393B、LM2903B、LM293、LM293A、LM393、LM393A、LM2903	VSSOP (8)	3.00mm x 3.00mm
LM293、LM393、LM393A、LM2903	PDIP (8)	9.81mm x 6.35mm
LM393、LM393A、LM2903	SO (8)	6.20mm x 5.30mm
LM393B、LM2903B、LM393、LM393A、LM2903、LM2903V、LM2903AV	TSSOP (8)	3.00mm x 4.40mm
LM393B、LM2903B	SOT-23 (8)	2.90mm x 1.60mm
LM393B、LM2903B	WSON (8)	2.00mm x 2.00mm

(1) 如需了解所有可用封装，请参阅数据表末尾的可订购产品附录。

#### 系列比较表

规格	LM393B	LM2903B	LM393 LM393A	LM2903	LM2903V LM2903AV	LM193	LM293 LM293A	单位
电源电压	2 至 36	2 至 36	2 至 30	2 至 30	2 至 32	2 至 30	2 至 30	V
总电源电流 (5V 至 36V 最大值)	0.6 至 0.8	0.6 至 0.8	1 至 2.5	1 至 2.5	1 至 2.5	1 至 2.5	1 至 2.5	mA
温度范围	-40 至 85	-40 至 125	0 至 70	-40 至 125	-40 至 125	-55 至 125	-25 至 85	°C
ESD (HBM)	2000	2000	1000	1000	1000	1000	1000	V
失调电压 (整个温度范围内的最大值)	$\pm 4$	$\pm 4$	$\pm 9$ $\pm 4$	$\pm 15$	$\pm 15$ $\pm 4$	$\pm 9$	$\pm 9$ $\pm 4$	mV
输入偏置电流 (典型值/最大值)	3.5/25	3.5/25	25/250	25/250	25/250	25/100	25/250	nA
响应时间 (典型值)	1	1	1.3	1.3	1.3	1.3	1.3	$\mu$ sec



## 内容

<b>1 特性</b> .....	1	6.14 LMx93 和 LM2903 ( 所有 “V” 和 “A” 后缀 ) 的典型特性.....	11
<b>2 应用</b> .....	1	6.15 LM393B 和 LM2903B 的典型特性.....	12
<b>3 说明</b> .....	1	<b>7 详细说明</b> .....	18
<b>4 修订历史记录</b> .....	2	7.1 概述.....	18
<b>5 引脚配置和功能</b> .....	3	7.2 功能方框图.....	18
<b>6 规格</b> .....	4	7.3 特性说明.....	18
6.1 绝对最大额定值.....	4	7.4 器件功能模式.....	18
6.2 建议运行条件.....	4	<b>8 应用和实施</b> .....	19
6.3 热性能信息 : LM193.....	5	8.1 应用信息.....	19
6.4 热性能信息 : LM293、LM393、LM2903 ( 所有 “V” 和 “A” 后缀 ) .....	5	8.2 典型应用.....	19
6.5 热性能信息 : LM393B 和 LM2903B.....	5	<b>9 电源相关建议</b> .....	21
6.6 ESD 等级.....	5	<b>10 布局</b> .....	21
6.7 LM393B 的电气特性.....	6	10.1 布局指南.....	21
6.8 LM2903B 的电气特性.....	7	10.2 布局示例.....	21
6.9 LM393B 和 LM2903B 的开关特性.....	7	<b>11 器件和文档支持</b> .....	22
6.10 LM193、LM293 和 LM393 ( 无 A 后缀 ) 的电气 特性 .....	8	11.1 Receiving Notification of Documentation Updates..	22
6.11 LM293A 和 LM393A 的电气特性.....	9	11.2 支持资源.....	22
6.12 LM2903、LM2903V 和 LM2903AV 的电气特性.....	10	11.3 商标.....	22
6.13 开关特性 : LM193、LM239、LM393、LM2903 ( 所有 “A” 和 “V” 版本 ) .....	10	11.4 静电放电警告.....	22
		11.5 术语表.....	22
		<b>12 机械、封装和可订购信息</b> .....	22

## 4 修订历史记录

注：以前版本的页码可能与当前版本的页码不同

### Changes from Revision AC (February 2020) to Revision AD (October 2020) Page

- 更新了整个文档中的表格、图和交叉参考的编号格式。..... 1

### Changes from Revision AB (December 2019) to Revision AC (February 2020) Page

- 更改了首页的“特性”、“应用”和“说明”文本，以突出 B 版本。..... 1
- 添加了 WSON 和 SOT-23-8 封装..... 1
- 添加了指向系列表的链接..... 1
- 在热性能表中添加了 DDF 和 DSG 封装..... 5

### Changes from Revision AA (September 2019) to Revision AB (December 2019) Page

- 将 LM393B 和 LM2903B 的状态从“预发布”更改为“正在供货”..... 1
- 添加了系列比较表..... 1

### Changes from Revision Z (October 2017) to Revision AA (September 2019) Page

- 在整个数据表中添加了“B”器件并更改了多处文本。..... 1
- 删除了“器件信息”中旧的 LM193 CDIP 和 LCCC 封装参考和图，这些内容包含在 LM139-MIL 数据表中。.. 1
- 添加了“B”器件热性能信息表。..... 5
- 添加了“B”器件电气表..... 5
- 添加了“B”器件图..... 12

## 5 引脚配置和功能



图 5-1. D、DGK、JG、P、PS、DDF 或 PW 封装 8 引脚 SOIC、VSSOP、PDIP、SO 或 TSSOP 顶视图



将散热焊盘直接连接到 GND 引脚。

图 5-2. DSG 封装 8 引脚 WSON (带有外露焊盘) 顶视图

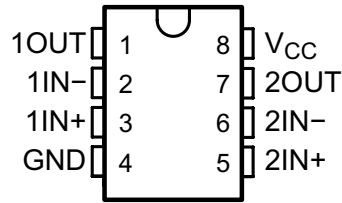
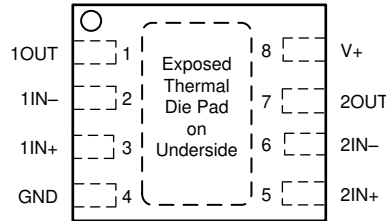
表 5-1. 引脚功能

名称	引脚		I/O	说明
	SOIC、VSSOP、PDIP、SO、DDF 和 TSSOP	DSG		
1OUT	1	1	输出	比较器 1 的输出引脚
1IN -	2	2	输入	比较器 1 的负输入引脚
1IN+	3	3	输入	比较器 1 的正输入引脚
GND	4	4	—	接地
2IN+	5	5	输入	比较器 2 的正输入引脚
2IN-	6	6	输入	比较器 2 的负输入引脚
2OUT	7	7	输出	比较器 2 的输出引脚
V <sub>CC</sub>	8	8	—	正电源
散热焊盘	—	PAD	—	直接连接到 GND 引脚

## 6 规格

### 6.1 绝对最大额定值

在自然通风条件下的工作温度范围内测得 (除非另有说明) <sup>(1)</sup>

		最小值	最大值	单位
V <sub>CC</sub> 电源电压 <sup>(2)</sup>	非 B 版本	- 0.3	36	V
	仅限 B 版本		38	
V <sub>ID</sub> 差动输入电压 <sup>(3)</sup>	非 B 版本	-36	36	V
	仅限 B 版本	-38	38	
V <sub>I</sub> 输入电压 (任一输入)	非 B 版本	- 0.3	36	V
	仅限 B 版本		38	
I <sub>IK</sub> 输入电流 <sup>(5)</sup>			-50	mA
V <sub>O</sub> 输出电压	非 B 版本	- 0.3	36	V
	仅限 B 版本		38	
I <sub>O</sub> 输出电流	非 B 版本		20	mA
	仅限 B 版本		25	
I <sub>SC</sub> 输出接地短路的持续时间 <sup>(4)</sup>			无限	
T <sub>J</sub> 运行虚拟结温			150	°C
T <sub>stg</sub> 贮存温度		- 65	150	°C

- 超出绝对最大额定值下列出的值的应力可能会对器件造成永久损坏。这些列出的值仅仅是应力额定值，这并不表示器件在这些条件下以及在建议运行条件以外的任何其他条件下能够正常运行。长时间在最大绝对额定条件下运行会影响器件可靠性。生产过程中没有必要对产品的所有参数进行测试。
- 除差分电压外的所有电压值都是相对于网络接地而言的。
- 差分电压是相对于 IN<sup>-</sup> 的 IN<sup>+</sup> 上的值。
- 从输出到 V<sub>CC</sub> 的短路会导致过热，并且最终会发生损坏。
- 输入电流通过寄生二极管流至接地端并开启寄生晶体管，这会增加 I<sub>CC</sub> 并可能导致输出不正确。移除输入电流后会恢复正常工作。

### 6.2 建议运行条件

在自然通风条件下的工作温度范围内测得 (除非另有说明)

		最小值	最大值	单位
电源电压, V <sub>S</sub> = (V <sup>+</sup> ) - (V <sup>-</sup> )	非 V 后缀器件	2	30	V
	V 后缀器件	2	32	
	“B” 版本器件	2	36	
输入电压范围, V <sub>IVR</sub>	非 B 后缀器件	0	(V <sup>+</sup> ) - 2.0	V
	“B” 版本器件	- 0.1		
环境温度, T <sub>A</sub>	LM193	- 55	125	°C
	LM2903, LM2903V, LM2903AV, LM2903B	-40	125	
	LM393B	- 40	85	
	LM293, LM293A	- 25	85	
	LM393, LM393A	0	70	

### 6.3 热性能信息：LM193

热指标 <sup>(1)</sup>		LM193	单位
		D (SOIC)	
		8 引脚	
R <sub>θJA</sub>	结至环境热阻	126.4	°C/W
R <sub>θJC(top)</sub>	结至外壳 (顶部) 热阻	70	°C/W
R <sub>θJB</sub>	结至电路板热阻	64.9	°C/W
ψ <sub>JT</sub>	结至顶部特征参数	20.3	°C/W
ψ <sub>JB</sub>	结至电路板特征参数	64.5	°C/W
R <sub>θJC(bot)</sub>	结至外壳 (底部) 热阻	不适用	°C/W

(1) 有关新旧热指标的更多信息，请参阅 [半导体和 IC 封装热指标](#) 报告。

### 6.4 热性能信息：LM293、LM393、LM2903 (所有“V”和“A”后缀)

热指标 <sup>(1)</sup>		LM293、LM393、LM2903					单位
		D (SOIC)	DGK (VSSOP)	P (PDIP)	PS (SO)	PW (TSSOP)	
		8 引脚	8 引脚	8 引脚	8 引脚	8 引脚	
R <sub>θJA</sub>	结至环境热阻	131.8	199.4	73.7	139	194.1	°C/W
R <sub>θJC(top)</sub>	结至外壳 (顶部) 热阻	78.4	90.2	62.6	98.9	77.0	°C/W
R <sub>θJB</sub>	结至电路板热阻	72.2	120.8	50.8	83.7	123.0	°C/W
ψ <sub>JT</sub>	结至顶部特征参数	26.5	21.5	39.2	47.4	13.1	°C/W
ψ <sub>JB</sub>	结至电路板特征参数	71.1	119.1	50.7	83	121.3	°C/W

(1) 有关新旧热指标的更多信息，请参阅 [半导体和 IC 封装热指标](#) 报告。

### 6.5 热性能信息：LM393B 和 LM2903B

热指标 <sup>(1)</sup>		LM393B、LM2903B					单位
		D (SOIC)	PW (TSSOP)	DGK (VSSOP)	DDF (SOT-23)	DSG (WSON)	
		8 引脚	8 引脚	8 引脚	8 引脚	8 引脚	
R <sub>θJA</sub>	结至环境热阻	148.5	200.6	193.7	197.9	96.9	°C/W
R <sub>θJC(top)</sub>	结至外壳 (顶部) 热阻	90.2	89.6	82.9	119.2	119.0	°C/W
R <sub>θJB</sub>	结至电路板热阻	91.8	131.3	115.5	115.4	63.1	°C/W
ψ <sub>JT</sub>	结至顶部特征参数	38.5	22.1	20.8	19.4	12.4	°C/W
ψ <sub>JB</sub>	结至电路板特征参数	91.1	129.6	113.9	113.7	63.0	°C/W
R <sub>θJC(bot)</sub>	结至外壳 (底部) 热阻	-	-	-	-	37.8	°C/W

(1) 有关新旧热指标的更多信息，请参阅 [半导体和 IC 封装热指标](#) 报告。

### 6.6 ESD 等级

		值	单位
<b>仅限 LM393B 和 LM2903B</b>			
V <sub>(ESD)</sub> 静电放电	人体放电模型 (HBM), 符合 ANSI/ESDA/JEDEC JS-001 <sup>(1)</sup>	±2000	V
	充电器件模型 (CDM), 符合 JEDEC 规范 JESD22-C101 <sup>(2)</sup>	±1000	
<b>所有其他版本</b>			
V <sub>(ESD)</sub> 静电放电	人体放电模型 (HBM), 符合 ANSI/ESDA/JEDEC JS-001 <sup>(1)</sup>	±1000	V
	充电器件模型 (CDM), 符合 JEDEC 规范 JESD22-C101 <sup>(2)</sup>	±750	

(1) JEDEC 文件 JEP155 指出：500V HBM 可实现在标准 ESD 控制流程下安全生产。

(2) JEDEC 文件 JEP157 指出：250V CDM 可实现在标准 ESD 控制流程下安全生产。

## 6.7 LM393B 的电气特性

$V_S = 5V$ ,  $V_{CM} = (V-)$ ;  $T_A = 25^\circ C$  (除非另有说明)。

参数		测试条件	最小值	典型值	最大值	单位
$V_{IO}$	输入失调电压	$V_S = 5$ 至 $36V$	-2.5	$\pm 0.37$	2.5	mV
		$V_S = 5$ 至 $36V$ , $T_A = -40^\circ C$ 至 $+85^\circ C$	-4		4	
	输入失调电压 (仅 DGK 封装)	$V_S = 5$ 至 $36V$	-3.5	$\pm 0.37$	3.5	
		$V_S = 5$ 至 $36V$ , $T_A = -40^\circ C$ 至 $+85^\circ C$	-5		5	
$I_B$	输入偏置电流			-3.5	-25	nA
		$T_A = -40^\circ C$ 至 $+85^\circ C$			-50	nA
$I_{OS}$	输入失调电流		-10	$\pm 0.5$	10	nA
		$T_A = -40^\circ C$ 至 $+85^\circ C$	-25		25	nA
$V_{CM}$	共模范围 (1)	$V_S = 3$ 至 $36V$	(V-)		(V+) - 1.5	V
		$V_S = 3$ 至 $36V$ , $T_A = -40^\circ C$ 至 $+85^\circ C$	(V-)		(V+) - 2.0	V
$A_{VD}$	大信号差分电压放大	$V_S = 15V$ , $V_O = 1.4V$ 至 $11.4V$ ; $R_L \geq 15k$ 至 (V+)	50	200		V/mV
$V_{OL}$	低电平输出电压 {相对于 (V-) 的摆幅}	$I_{SINK} \leq 4mA$ , $V_{ID} = -1V$		110	400	mV
		$I_{SINK} \leq 4mA$ , $V_{ID} = -1V$ $T_A = -40^\circ C$ 至 $+85^\circ C$			550	mV
$I_{OH-LKG}$	高电平输出漏电流	(V+) = $V_O = 5V$ ; $V_{ID} = 1V$		0.1	20	nA
		(V+) = $V_O = 36V$ ; $V_{ID} = 1V$		0.3	50	nA
$I_{OL}$	低电平输出电流	$V_{OL} = 1.5V$ ; $V_{ID} = -1V$ ; $V_S = 5V$	6	21		mA
$I_Q$	静态电流 (所有比较器)	$V_S = 5V$ , 空载		400	600	$\mu A$
		$V_S = 36V$ , 空载, $T_A = -40^\circ C$ 至 $+85^\circ C$		550	800	$\mu A$

- (1) 任一输入端的电压不应低于负 0.3V, 否则输出可能不正确, 并且可能产生过大的输入电流。共模电压范围的上限受  $V_{CC} - 2V$  的限制。不过, 只有一个输入需要处于有效的共模范围之内, 另一个输入可以达到最大  $V_{CC}$  电平, 比较器会提供适当的输出状态。任一输入或两个输入可以达到最大  $V_{CC}$  电平而不会造成损坏。

## 6.8 LM2903B 的电气特性

$V_S = 5V$ ,  $V_{CM} = (V_-)$ ;  $T_A = 25^\circ C$  (除非另有说明)。

参数		测试条件	最小值	典型值	最大值	单位
$V_{IO}$	输入失调电压	$V_S = 5$ 至 $36V$	-2.5	$\pm 0.37$	2.5	mV
		$V_S = 5$ 至 $36V$ , $T_A = -40^\circ C$ 至 $+125^\circ C$	-4		4	
	输入失调电压 (仅 DGK 封装)	$V_S = 5$ 至 $36V$	-3.5	$\pm 0.37$	3.5	
		$V_S = 5$ 至 $36V$ , $T_A = -40^\circ C$ 至 $+125^\circ C$	-5		5	
$I_B$	输入偏置电流			-3.5	-25	nA
		$T_A = -40^\circ C$ 至 $+125^\circ C$			-50	nA
$I_{OS}$	输入失调电流		-10	$\pm 0.5$	10	nA
		$T_A = -40^\circ C$ 至 $+125^\circ C$	-25		25	nA
$V_{CM}$	共模范围 (1)	$V_S = 3$ 至 $36V$	$(V_-)$		$(V_+) - 1.5$	V
		$V_S = 3$ 至 $36V$ , $T_A = -40^\circ C$ 至 $+125^\circ C$	$(V_-)$		$(V_+) - 2.0$	V
$A_{VD}$	大信号差分电压放大	$V_S = 15V$ , $V_O = 1.4V$ 至 $11.4V$ ; $R_L \geq 15k$ 至 $(V_+)$	50	200		V/mV
$V_{OL}$	低电平输出电压 {相对于 $(V_-)$ 的摆幅}	$I_{SINK} \leq 4mA$ , $V_{ID} = -1V$		110	400	mV
		$I_{SINK} \leq 4mA$ , $V_{ID} = -1V$ $T_A = -40^\circ C$ 至 $+125^\circ C$			550	mV
$I_{OH-LKG}$	高电平输出漏电流	$(V_+) = V_O = 5V$ ; $V_{ID} = 1V$		0.1	20	nA
		$(V_+) = V_O = 36V$ ; $V_{ID} = 1V$		0.3	50	nA
$I_{OL}$	低电平输出电流	$V_{OL} = 1.5V$ ; $V_{ID} = -1V$ ; $V_S = 5V$	6	21		mA
$I_Q$	静态电流 (所有比较器)	$V_S = 5V$ , 空载		400	600	$\mu A$
		$V_S = 36V$ , 空载, $T_A = -40^\circ C$ 至 $+125^\circ C$		550	800	$\mu A$

- (1) 任一输入端的电压不应低于负 0.3V, 否则输出可能不正确, 并且可能产生过大的输入电流。共模电压范围的上限受  $V_{CC} - 2V$  的限制。不过, 只有一个输入需要处于有效的共模范围之内, 另一个输入可以达到最大  $V_{CC}$  电平, 比较器会提供适当的输出状态。任一输入或两个输入可以达到最大  $V_{CC}$  电平而不会造成损坏。

## 6.9 LM393B 和 LM2903B 的开关特性

$V_S = 5V$ ,  $V_O PULLUP = 5V$ ,  $V_{CM} = V_S/2$ ,  $C_L = 15pF$ ,  $R_L = 5.1k$  欧姆,  $T_A = 25^\circ C$  (除非另有说明)。

参数		测试条件	最小值	典型值	最大值	单位
$t_{响应}$	高电平到低电平的传播延迟时间; TTL 输入信号 (1)	$V_{ref} = 1.4V$ 时的 TTL 输入		300		ns
$t_{响应}$	高电平到低电平的传播延迟时间; 小规模输入信号 (1)	输入过驱 = 5mV, 输入阶跃 = 100mV		1000		ns

- (1) 高电平到低电平以及低电平到高电平是指输入端的转换。

## 6.10 LM193、LM293 和 LM393 (无 A 后缀) 的电气特性

在指定自然通风温度下,  $V_{CC} = 5V$  (除非另有说明)

参数	测试条件		$T_A$ (1)	LM193			LM293 LM393			单位
				最小值	典型值	最大值	最小值	典型值	最大值	
$V_{IO}$ 输入失调电压	$V_{CC} = 5V$ 至 $30V$ , $V_{IC} = V_{ICR}$ 最小值, $V_O = 1.4V$		25°C	2	5	2	5	mV		
			完整范围	9						
$I_{IO}$ 输入失调电流	$V_O = 1.4V$		25°C	3	25	5	50	nA		
			完整范围	100			250			
$I_{IB}$ 输入偏置电流	$V_O = 1.4V$		25°C	-25	-100	-25	-250	nA		
			完整范围	-300			-400			
$V_{ICR}$ 共模输入电压范围(2)			25°C	0 至 $V_{CC} - 1.5$		0 至 $V_{CC} - 1.5$		V		
			完整范围	0 至 $V_{CC} - 2$		0 至 $V_{CC} - 2$				
$A_{VD}$ 大信号差分电压放大	$V_{CC} = 15V$ , $V_O = 1.4V$ 至 $11.4V$ , $R_L \geq 15k\Omega$ 至 $V_{CC}$		25°C	50	200	50	200	V/mV		
$I_{OH}$ 高电平输出电流	$V_{OH} = 5V$	$V_{ID} = 1V$	25°C	0.1			0.1	50	nA	
	$V_{OH} = 30V$	$V_{ID} = 1V$	完整范围	1			1		$\mu A$	
$V_{OL}$ 低电平输出电压	$I_{OL} = 4mA$ , $V_{ID} = -1V$		25°C	150	400	130	400	mV		
			完整范围	700			700			
$I_{OL}$ 低电平输出电流	$V_{OL} = 1.5V$ ,	$V_{ID} = -1V$	25°C	6			6	mA		
$I_{CC}$ 电源电流	$R_L = \infty$		$V_{CC} = 5V$	0.8		0.45	1	mA		
			完整范围	2.5			0.55		2.5	

- (1) LM193 的完整范围 (最小值或最大值) 为  $-55^\circ C$  至  $125^\circ C$ , LM293 的完整范围为  $-25^\circ C$  至  $85^\circ C$ , LM393 的完整范围为  $0^\circ C$  至  $70^\circ C$ 。除非另有说明, 否则所有特性均在零共模输入电压下测量。
- (2) 任一输入端的电压不应低于负  $0.3V$ , 否则输出可能不正确, 并且可能产生过大的输入电流。共模电压范围的上限受  $V_{CC} - 2V$  的限制。不过, 只有一个输入需要处于有效的共模范围之内, 另一个输入可以达到最大  $V_{CC}$  电平, 比较器会提供适当的输出状态。任一输入或两个输入可以达到最大  $V_{CC}$  电平而不会造成损坏。



## 6.11 LM293A 和 LM393A 的电气特性

在指定自然通风温度下， $V_{CC} = 5V$  (除非另有说明)

参数	测试条件	$T_A$ (1)	LM293A LM393A		单位
			最小值	典型值 最大值	
$V_{IO}$ 输入失调电压	$V_{CC} = 5V$ 至 $30V$ , $V_O = 1.4V$ $V_{IC} = V_{ICR(min)}$	$25^\circ C$	1	2	mV
		完整范围	4		
$I_{IO}$ 输入失调电流	$V_O = 1.4V$	$25^\circ C$	5	50	nA
		完整范围	150		
$I_{IB}$ 输入偏置电流	$V_O = 1.4V$	$25^\circ C$	-25	-250	nA
		完整范围	-400		
$V_{ICR}$ 共模输入电压范围(2)		$25^\circ C$	0 至 $V_{CC} - 1.5$		V
		完整范围	0 至 $V_{CC} - 2$		
$A_{VD}$ 大信号差分电压放大	$V_{CC} = 15V$ , $V_O = 1.4V$ 至 $11.4V$ , $R_L \geq 15k\Omega$ 至 $V_{CC}$	$25^\circ C$	50	200	V/mV
$I_{OH}$ 高电平输出电流	$V_{OH} = 5V$ , $V_{ID} = 1V$	$25^\circ C$	0.1	50	nA
	$V_{OH} = 30V$ , $V_{ID} = 1V$	完整范围	1		$\mu A$
$V_{OL}$ 低电平输出电压	$I_{OL} = 4mA$ , $V_{ID} = -1V$	$25^\circ C$	110	400	mV
		完整范围	700		
$I_{OL}$ 低电平输出电流	$V_{OL} = 1.5V$ , $V_{ID} = -1V$ ,	$25^\circ C$	6		mA
$I_{CC}$ 电源电流	$R_L = \infty$	$V_{CC} = 5V$	0.60	1	mA
		$V_{CC} = 30V$	0.72	2.5	

- (1) LM293A 的完整范围 (最小值或最大值) 为  $-25^\circ C$  至  $85^\circ C$ , LM393A 的完整范围为  $0^\circ C$  至  $70^\circ C$ 。除非另有说明, 否则所有特性均在零共模输入电压下测量。
- (2) 任一输入端的电压不应低于负  $0.3V$ , 否则输出可能不正确, 并且可能产生过大的输入电流。共模电压范围的上限受  $V_{CC} - 2V$  的限制。不过, 只有一个输入需要处于有效的共模范围之内, 另一个输入可以达到最大  $V_{CC}$  电平, 比较器会提供适当的输出状态。任一输入或两个输入可以达到最大  $V_{CC}$  电平而不会造成损坏。

## 6.12 LM2903、LM2903V 和 LM2903AV 的电气特性

在指定自然通风温度下， $V_{CC} = 5V$  (除非另有说明)

参数	测试条件	$T_A$ (1)	LM2903、LM2903V			LM2903AV			单位	
			最小值	典型值	最大值	最小值	典型值	最大值		
$V_{IO}$ 输入失调电压	$V_{CC} = 5V$ 至最大值(2), $V_O = 1.4V$ , $V_{IC} = V_{ICR(min)}$ ,	25°C		2	7		1	2	mV	
		完整范围			15			4		
$I_{IO}$ 输入失调电流	$V_O = 1.4V$	25°C		5	50		5	50	nA	
		完整范围			200			200		
$I_{IB}$ 输入偏置电流	$V_O = 1.4V$	25°C		-25	-250		-25	-250	nA	
		完整范围			-500			-500		
$V_{ICR}$ 共模输入电压范围(3)		25°C		0 至 $V_{CC} - 1.5$			0 至 $V_{CC} - 1.5$		V	
		完整范围		0 至 $V_{CC} - 2$			0 至 $V_{CC} - 2$			
$A_{VD}$ 大信号差分电压放大	$V_{CC} = 15V$ , $V_O = 1.4V$ 至 11.4V, $R_L \geq 15k\Omega$ 至 $V_{CC}$	25°C		25	100		25	100	V/mV	
$I_{OH}$ 高电平输出电流	$V_{OH} = 5V$ , $V_{ID} = 1V$	25°C			0.1	50		0.1	50	nA
	$V_{OH} = V_{CC}$ 最大值(2), $V_{ID} = 1V$	完整范围				1			1	$\mu A$
$V_{OL}$ 低电平输出电压	$I_{OL} = 4mA$ , $V_{ID} = -1V$ ,	25°C			150	400		150	400	mV
		完整范围				700			700	
$I_{OL}$ 低电平输出电流	$V_{OL} = 1.5V$ , $V_{ID} = -1V$	25°C			6			6	mA	
$I_{CC}$ 电源电流	$R_L = \infty$	$V_{CC} = 5V$	25°C			0.8		0.8	1	mA
		$V_{CC} =$ 最大值	完整范围				2.5			

- (1) LM2903 的完整范围 (最小值或最大值) 为  $-40^\circ C$  至  $125^\circ C$ 。除非另有说明，否则所有特性均在零共模输入电压下测量。
- (2)  $V_{CC}$  最大值对于非 V 后缀器件为 30V，对于 V 后缀器件为 32V。
- (3) 任一输入端的电压不应低于负 0.3V，否则输出可能不正确，并且可能产生过大的输入电流。共模电压范围的上限受  $V_{CC} - 2V$  的限制。不过，只有一个输入需要处于有效的共模范围之内，另一个输入可以达到最大  $V_{CC}$  电平，比较器会提供适当的输出状态。任一输入或两个输入可以达到最大  $V_{CC}$  电平而不会造成损坏。

## 6.13 开关特性：LM193、LM293、LM393、LM2903 (所有“A”和“V”版本)

$V_{CC} = 5V$ ,  $T_A = 25^\circ C$

参数	测试条件	典型值	单位
响应时间	$R_L$ 通过 5.1k $\Omega$ 连接到 5V, $C_L = 15pF$ (1)(2)	100mV 输入阶跃, 过驱为 5mV	1.3
		TTL 电平输入阶跃	0.3

- (1)  $C_L$  包括探头和夹具电容。
- (2) 指定的响应时间是输入阶跃函数与输出超过 1.4V 的瞬间之间的时间间隔。

### 6.14 LMx93 和 LM2903 ( 所有 “V” 和 “A” 后缀 ) 的典型特性

$T_A = 25^\circ\text{C}$ ,  $V_S = 5\text{V}$ ,  $R_{\text{PULLUP}} = 5.1\text{k}$ ,  $C_L = 15\text{pF}$ ,  $V_{\text{CM}} = 0\text{V}$  ( 除非另有说明 )。



图 6-1. 电源电流与电源电压之间的关系



图 6-2. 输入偏置电流与电源电压之间的关系

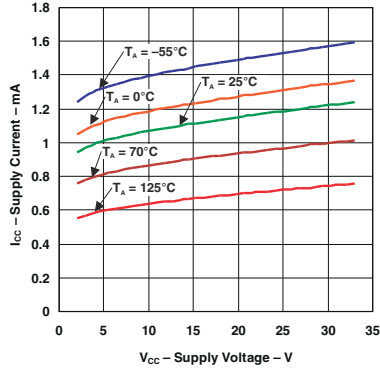

图 6-3. 输出饱和电压

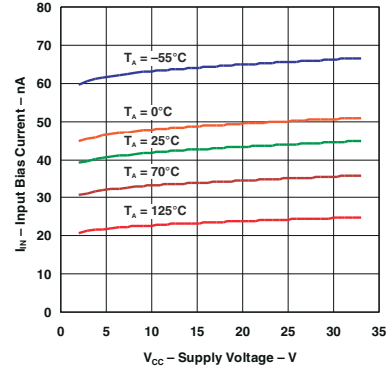

图 6-4. 负转换时各种过驱的响应时间

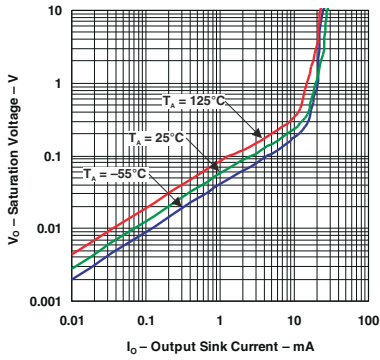

图 6-5. 正转换时各种过驱的响应时间

## 6.15 LM393B 和 LM2903B 的典型特性

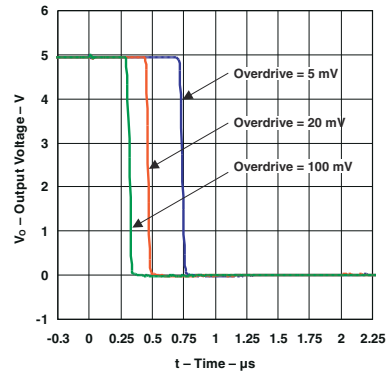
$T_A = 25^\circ\text{C}$ ,  $V_S = 5\text{V}$ ,  $R_{\text{PULLUP}} = 5.1\text{k}$ ,  $C_L = 15\text{pF}$ ,  $V_{\text{CM}} = 0\text{V}$ ,  $V_{\text{UNDERDRIVE}} = 100\text{mV}$ ,  $V_{\text{OVERDRIVE}} = 100\text{mV}$  (除非另有说明)。

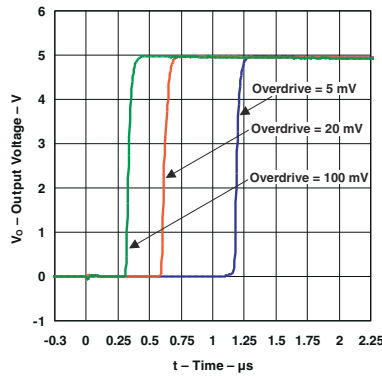

图 6-6. 总电源电流与电源电压之间的关系



图 6-7. 3V 下总电源电流与输入电压之间的关系

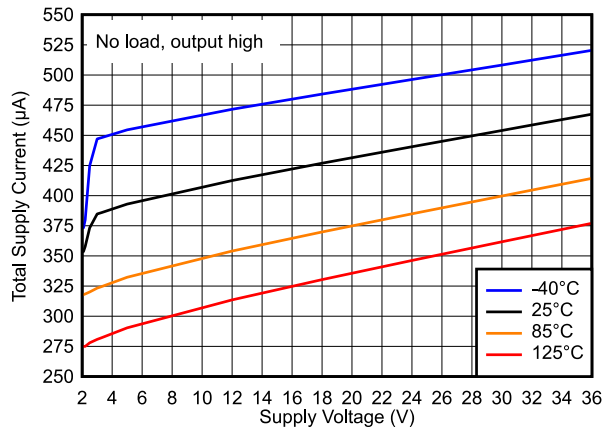

图 6-8. 3.3V 下总电源电流与输入电压之间的关系

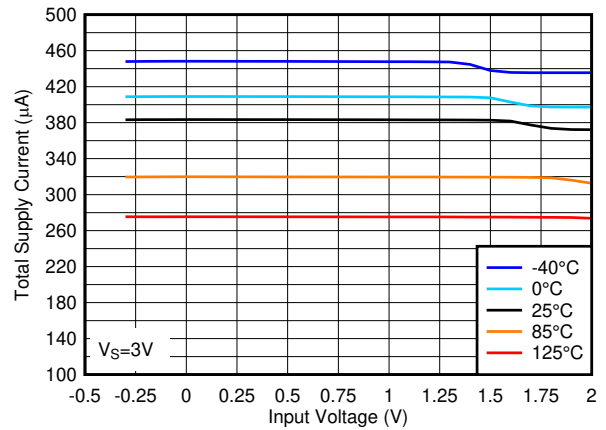

图 6-9. 5V 下总电源电流与输入电压之间的关系

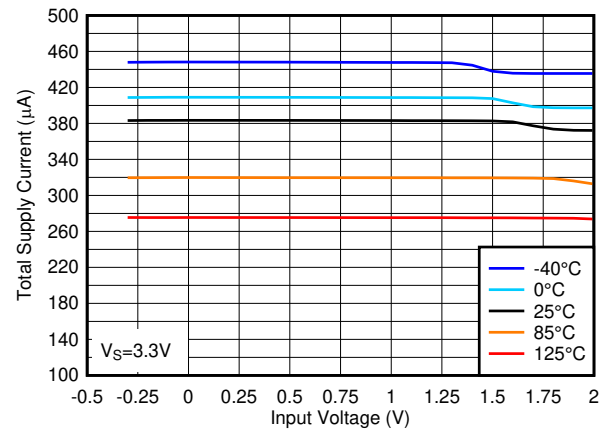

图 6-10. 12V 下总电源电流与输入电压之间的关系

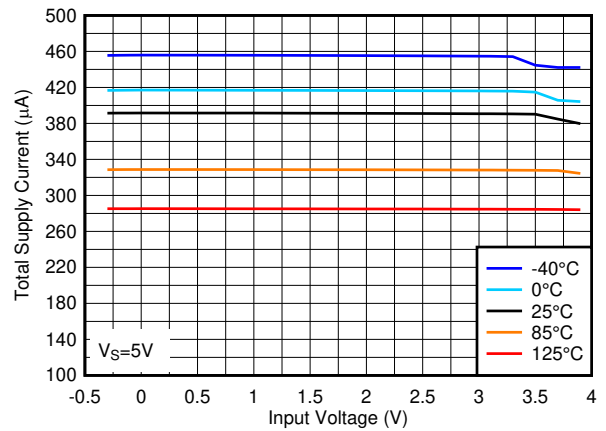

图 6-11. 36V 下总电源电流与输入电压之间的关系

### 6.15 LM393B 和 LM2903B 的典型特性 (continued)

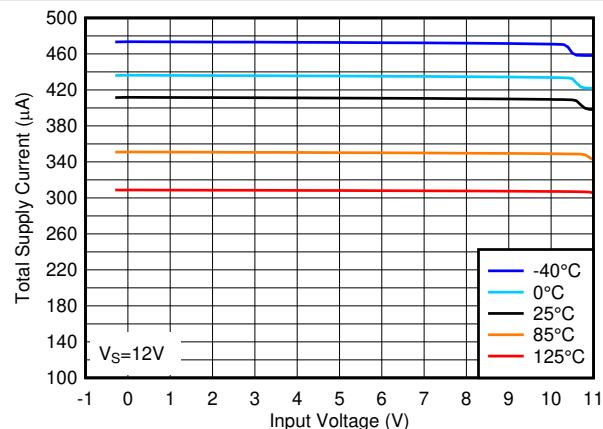
$T_A = 25^\circ\text{C}$ ,  $V_S = 5\text{V}$ ,  $R_{\text{PULLUP}} = 5.1\text{k}$ ,  $C_L = 15\text{pF}$ ,  $V_{\text{CM}} = 0\text{V}$ ,  $V_{\text{UNDERDRIVE}} = 100\text{mV}$ ,  $V_{\text{OVERDRIVE}} = 100\text{mV}$  (除非另有说明)。

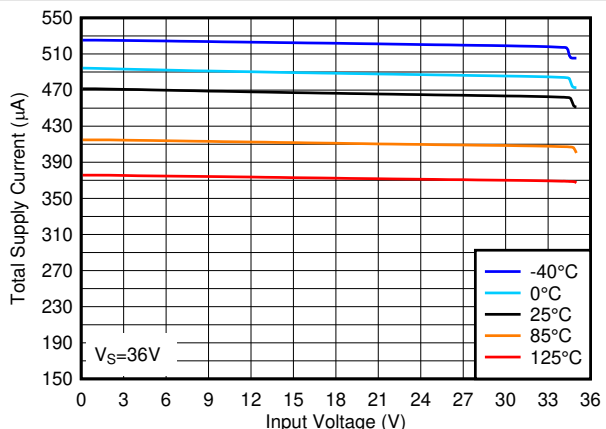

图 6-12. 3V 下输入失调电压与温度之间的关系



图 6-13. 5V 下输入失调电压与温度之间的关系

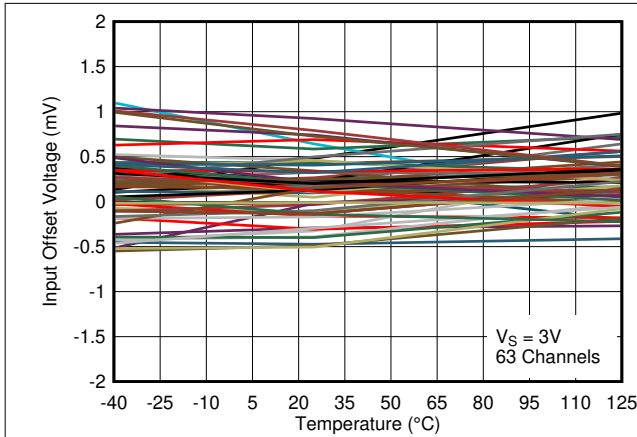

图 6-14. 12V 下输入失调电压与温度之间的关系

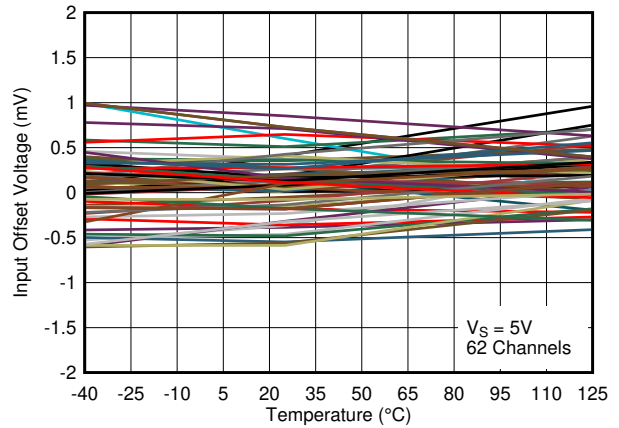

图 6-15. 36V 下输入失调电压与温度之间的关系

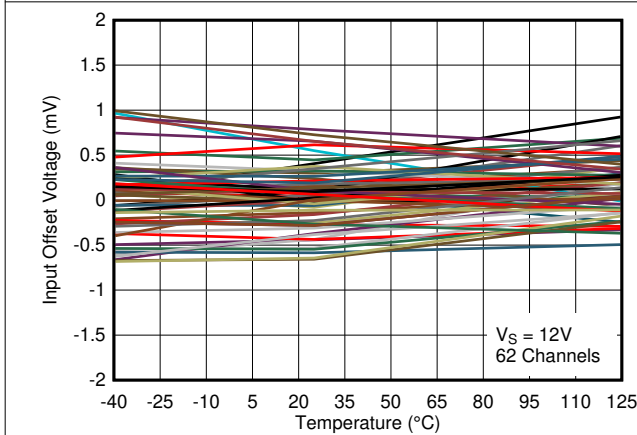

图 6-16. -40°C 下输入失调电压与电源电压之间的关系

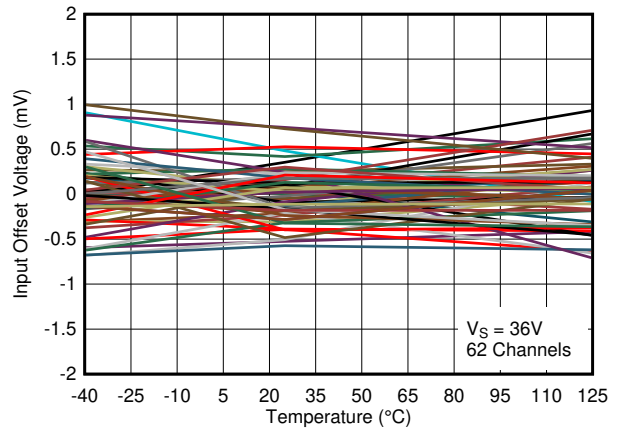

图 6-17. 25°C 下输入失调电压与电源电压之间的关系

### 6.15 LM393B 和 LM2903B 的典型特性 (continued)

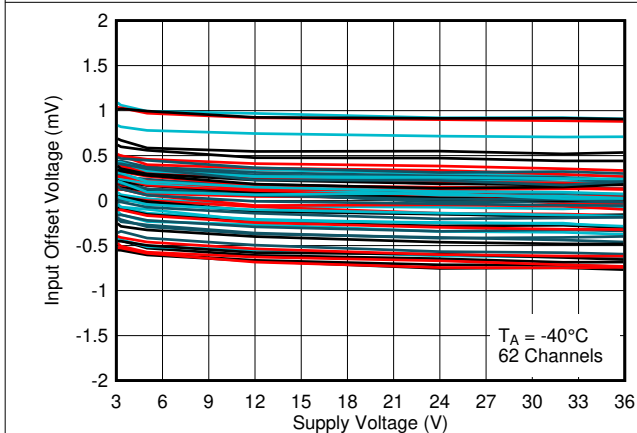
$T_A = 25^\circ\text{C}$ ,  $V_S = 5\text{V}$ ,  $R_{\text{PULLUP}} = 5.1\text{k}$ ,  $C_L = 15\text{pF}$ ,  $V_{\text{CM}} = 0\text{V}$ ,  $V_{\text{UNDERDRIVE}} = 100\text{mV}$ ,  $V_{\text{OVERDRIVE}} = 100\text{mV}$  (除非另有说明)。

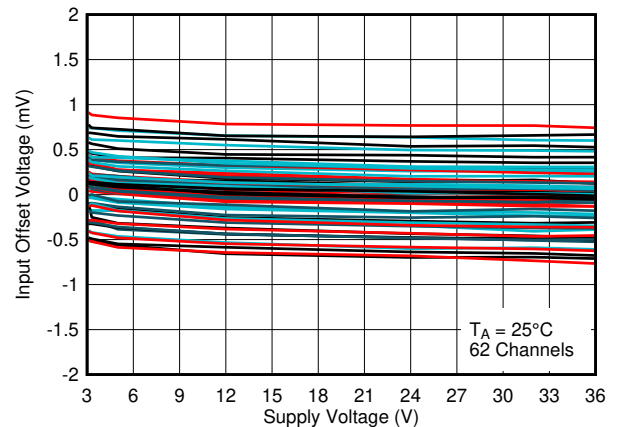

图 6-18. 85°C 下输入失调电压与电源电压之间的关系



图 6-19. 125°C 下输入失调电压与电源电压之间的关系

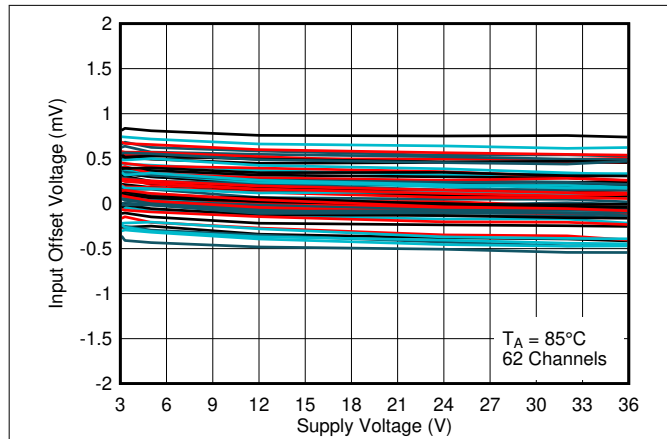

图 6-20. 输入偏置电流与电源电压之间的关系

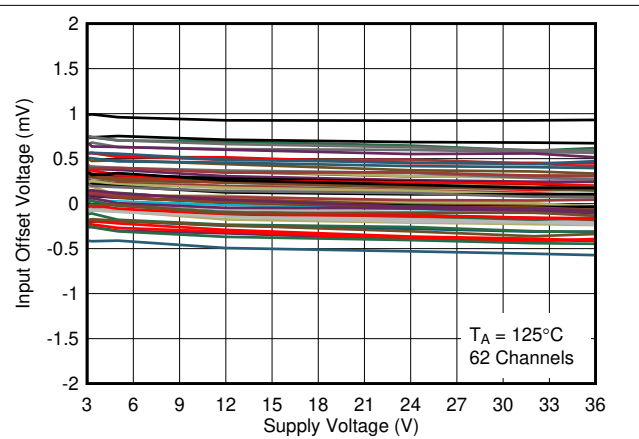

图 6-21. 5V 下输入偏置电流与输入电压之间的关系

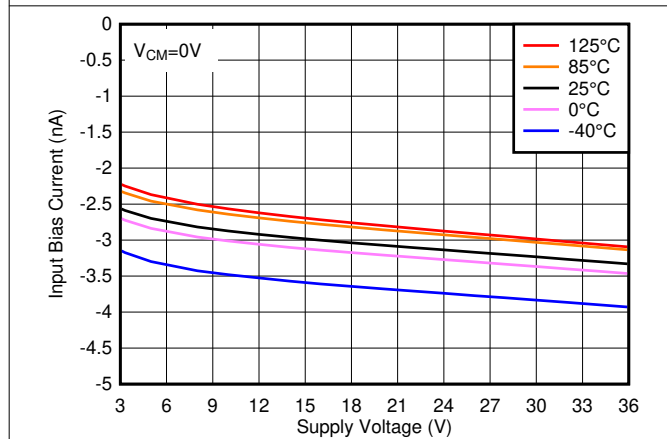

图 6-22. 12V 下输入偏置电流与输入电压之间的关系

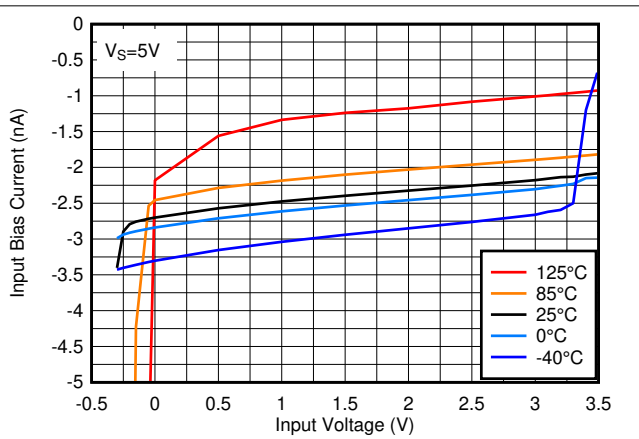

图 6-23. 36V 下输入偏置电流与输入电压之间的关系

### 6.15 LM393B 和 LM2903B 的典型特性 (continued)

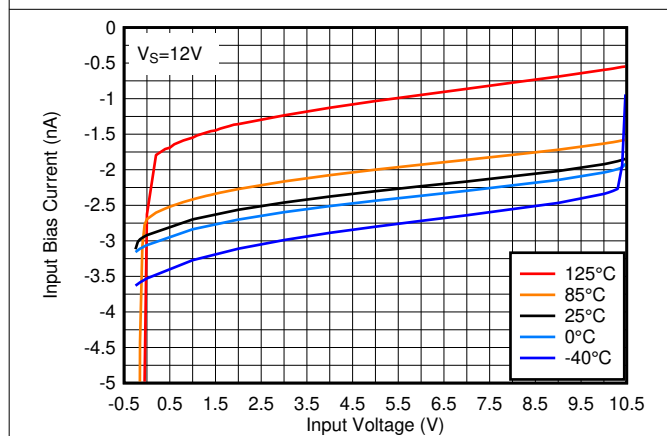
$T_A = 25^\circ\text{C}$ ,  $V_S = 5\text{V}$ ,  $R_{\text{PULLUP}} = 5.1\text{k}$ ,  $C_L = 15\text{pF}$ ,  $V_{\text{CM}} = 0\text{V}$ ,  $V_{\text{UNDERDRIVE}} = 100\text{mV}$ ,  $V_{\text{OVERDRIVE}} = 100\text{mV}$  (除非另有说明)。

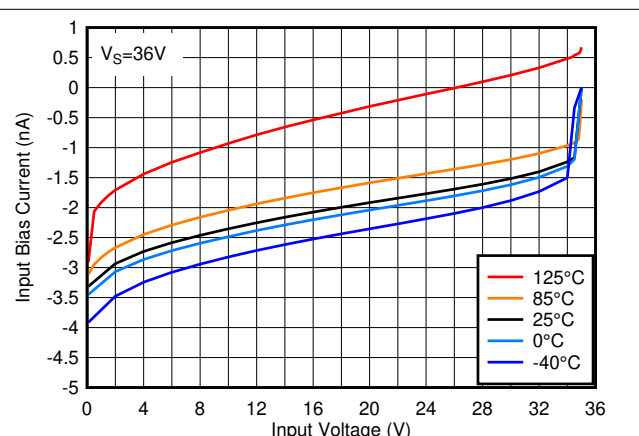

图 6-24. 3V 下输出低电平电压与输出灌电流之间的关系



图 6-25. 5V 下输出低电平电压与输出灌电流之间的关系

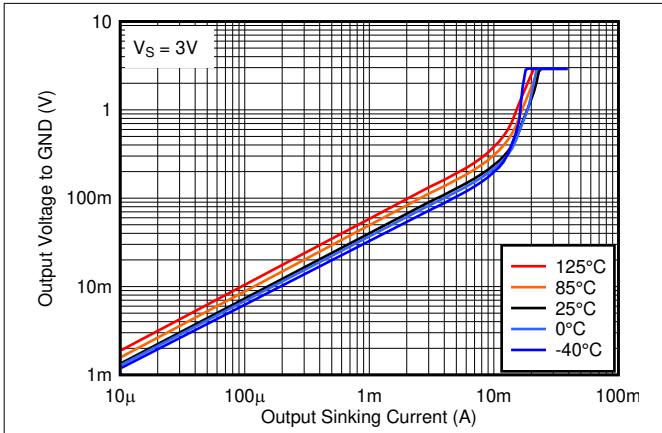

图 6-26. 12V 下输出低电平电压与输出灌电流之间的关系

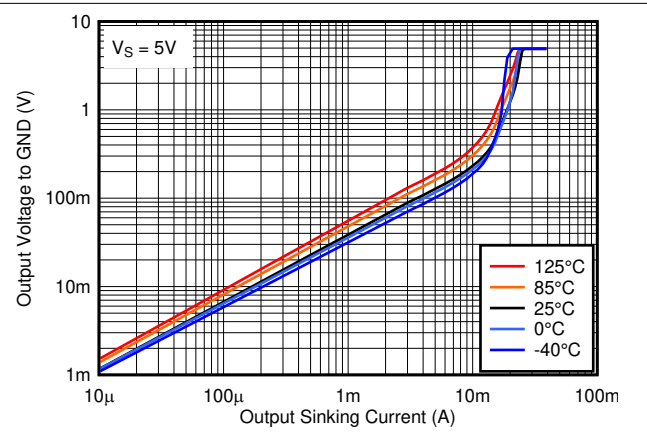

图 6-27. 36V 下输出低电平电压与输出灌电流之间的关系

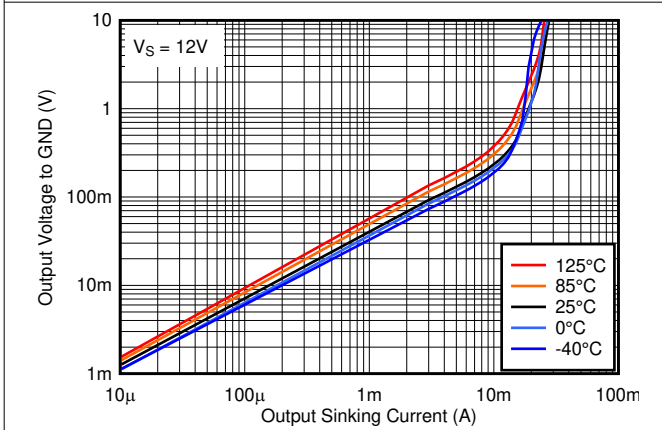

图 6-28. 5V 下输出高电平漏电流与温度之间的关系

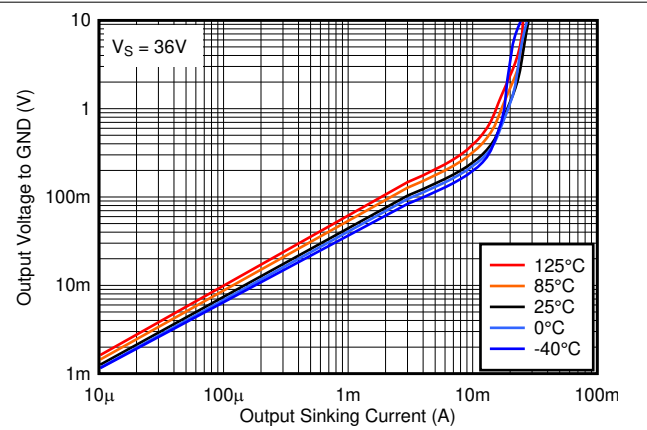

图 6-29. 36V 下输出高电平漏电流与温度之间的关系

## 6.15 LM393B 和 LM2903B 的典型特性 (continued)

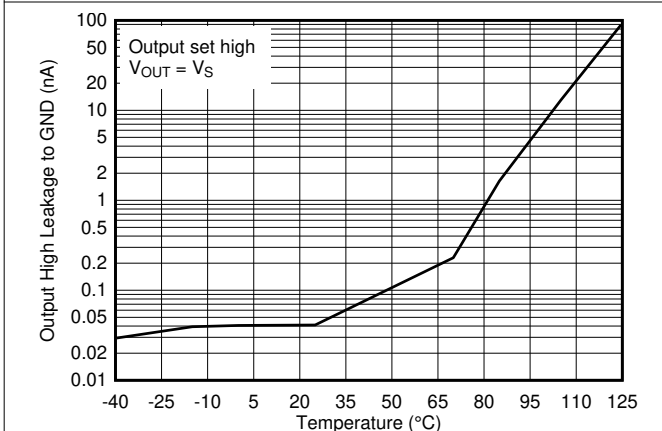
$T_A = 25^\circ\text{C}$ ,  $V_S = 5\text{V}$ ,  $R_{\text{PULLUP}} = 5.1\text{k}$ ,  $C_L = 15\text{pF}$ ,  $V_{\text{CM}} = 0\text{V}$ ,  $V_{\text{UNDERDRIVE}} = 100\text{mV}$ ,  $V_{\text{OVERDRIVE}} = 100\text{mV}$  (除非另有说明)。

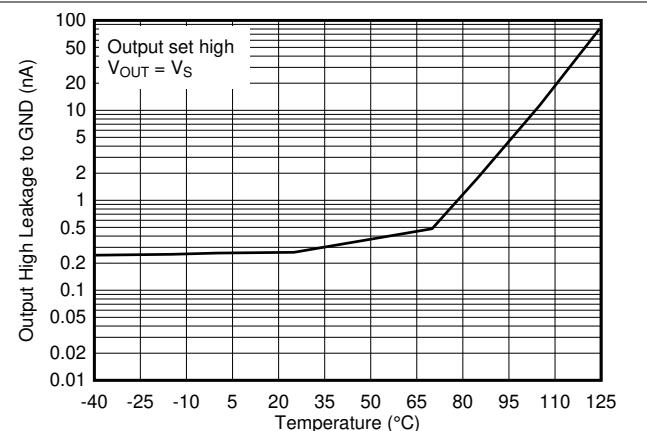

图 6-30. 高电平至低电平传播延迟与输入过驱电压之间的关系, 5V



图 6-31. 低电平至高电平传播延迟与输入过驱电压之间的关系, 5V

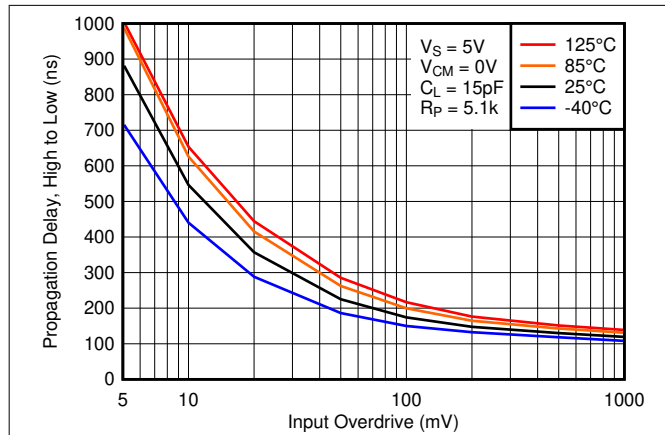

图 6-32. 高电平至低电平传播延迟与输入过驱电压之间的关系, 12V

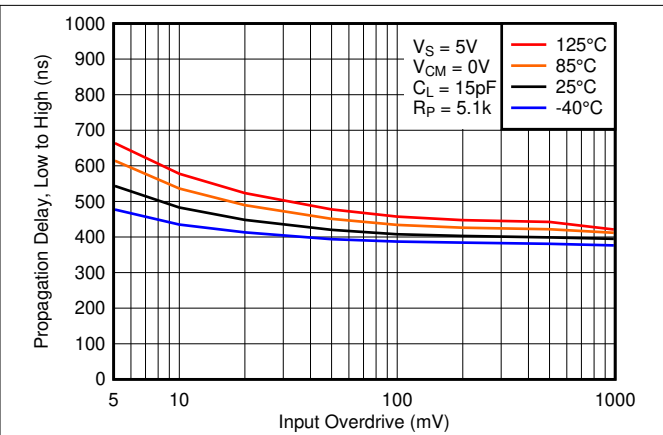

图 6-33. 低电平至高电平传播延迟与输入过驱电压之间的关系, 12V

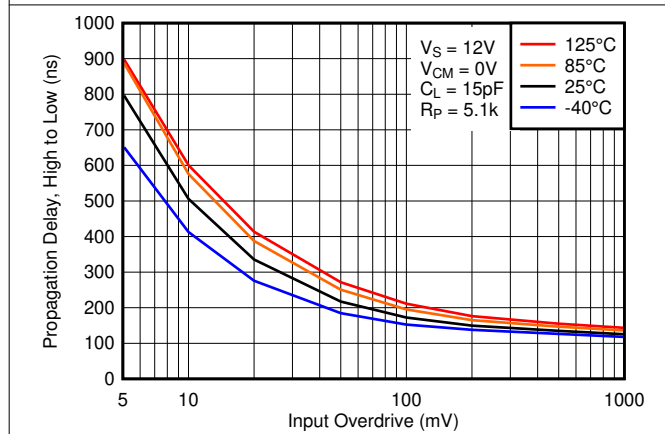

图 6-34. 高电平至低电平传播延迟与输入过驱电压之间的关系, 36V

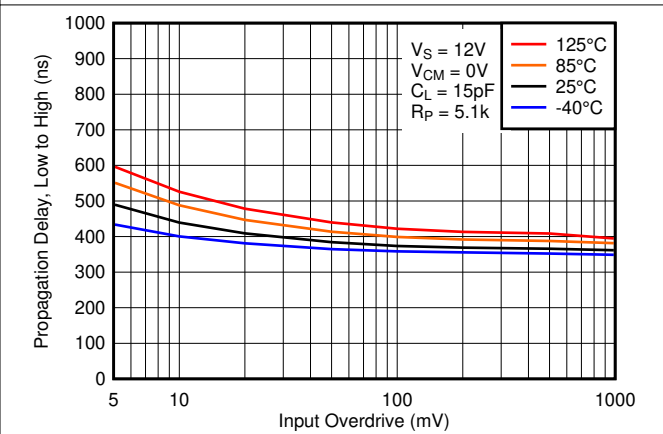

图 6-35. 低电平至高电平传播延迟与输入过驱电压之间的关系, 36V

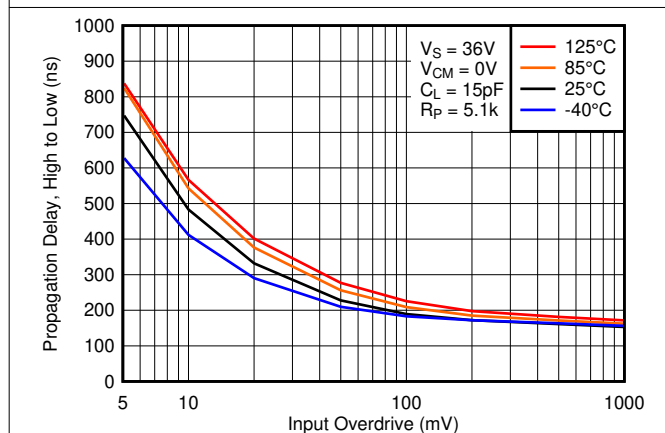

### 6.15 LM393B 和 LM2903B 的典型特性 (continued)

$T_A = 25^\circ\text{C}$ ,  $V_S = 5\text{V}$ ,  $R_{\text{PULLUP}} = 5.1\text{k}$ ,  $C_L = 15\text{pF}$ ,  $V_{\text{CM}} = 0\text{V}$ ,  $V_{\text{UNDERDRIVE}} = 100\text{mV}$ ,  $V_{\text{OVERDRIVE}} = 100\text{mV}$  (除非另有说明)。

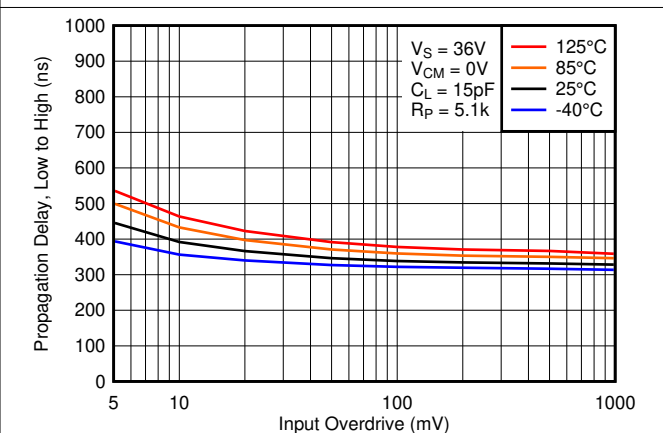
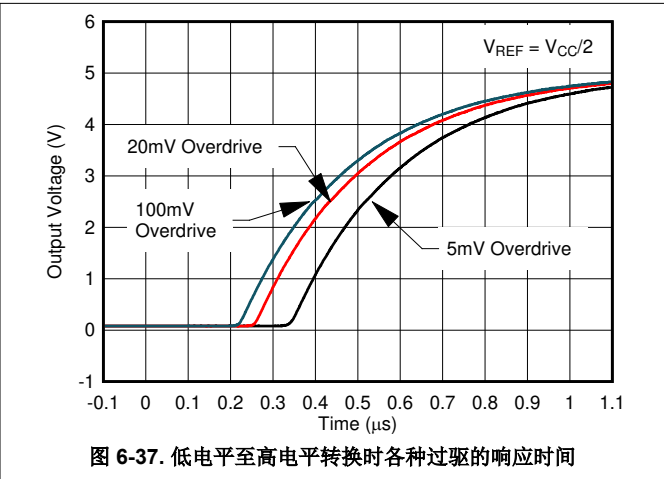
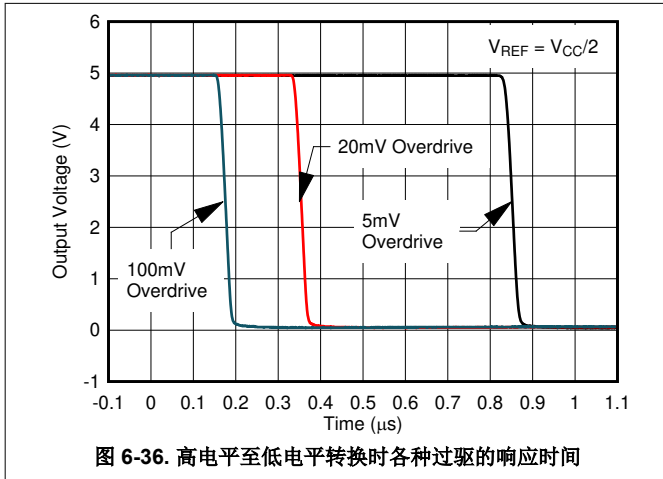

## 7 详细说明

### 7.1 概述

这些双路比较器能够在电源引脚上的电压高达 36V (对于“B”版本为 38V) 绝对最大值的情况下运行。这些器件已经证明可广泛应用于各种应用。这是因为这些器件具有非常宽的电源电压范围、低  $I_q$  和快速响应。

利用开漏输出，用户可以配置输出的逻辑高电压 ( $V_{OH}$ )，并可使比较器用于与功能。

### 7.2 功能方框图



图 7-1. 原理图 (每个比较器)

### 7.3 特性说明

该比较器由一个 PNP 达林顿对输入组成，允许该器件以非常高的增益和快速响应以及很小的输入偏置电流运行。输入达林顿对限制了输入共模电压能力，允许比较器在接地至  $V_{CC} - 1.5V$  的输入下准确运行。在低温下允许  $V_{CC} - 2V$ 。

输出由一个漏极开路 NPN (下拉或低侧) 晶体管组成。当负输入电压高于正输入电压和失调电压时，输出 NPN 灌入电流。 $V_{OL}$  是电阻性的，并且与输出电流成比例。有关相对于输出电流的  $V_{OL}$  值，请参阅图 6-3。

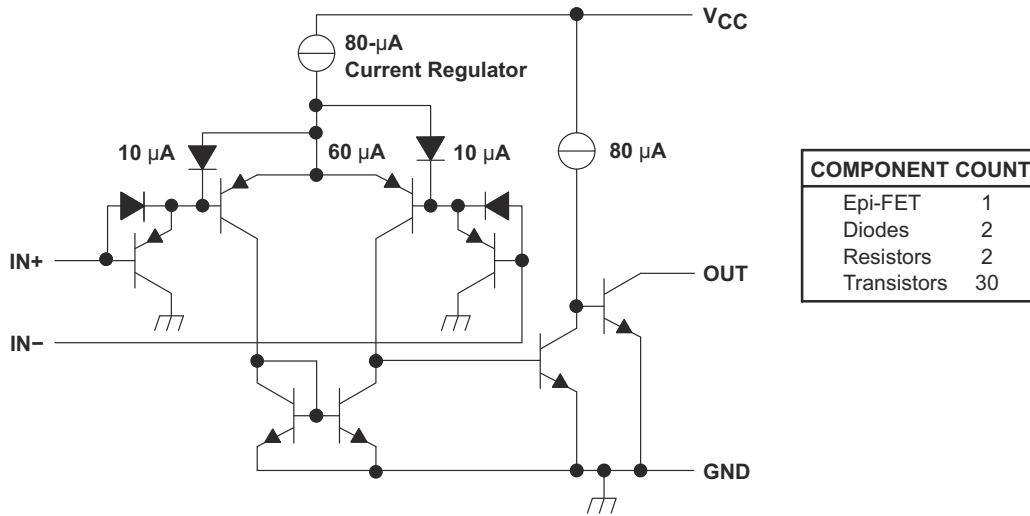
### 7.4 器件功能模式

#### 7.4.1 电压比较

该器件仅用作电压比较器，比较正负引脚之间的差分电压，并根据输入差分极性输出逻辑低阻抗或高阻抗 (带上拉的逻辑高电平)。

## 8 应用和实施

### 备注

以下应用部分的信息不属于 TI 组件规范，TI 不担保其准确性和完整性。客户应负责确定 TI 组件是否适用于其应用。客户应验证并测试其设计，以确保系统功能。

### 8.1 应用信息

该器件通常用于将单个信号与基准进行比较，或将两个信号相互比较。许多用户利用漏极开路输出将比较逻辑输出驱动至 MCU 或逻辑器件的逻辑电压电平。宽电源电压范围和高电压能力使该比较器非常适合到更高或更低电压的电平转换。

### 8.2 典型应用



图 8-1. 单端和差分比较器配置

#### 8.2.1 设计要求

本设计示例使用表 8-1 中所列的参数作为输入参数。

表 8-1. 设计参数

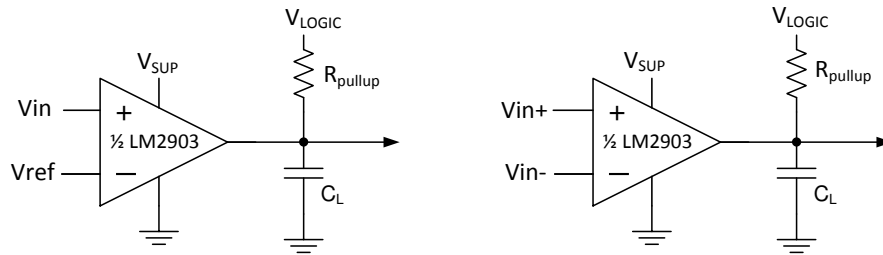
设计参数	示例值
输入电压范围	0V 至 $V_{sup}-2V$
电源电压	4.5V 至 $V_{CC}$ 最大值
逻辑电源电压	0V 至 $V_{CC}$ 最大值
输出电流 ( $R_{PULLUP}$ )	1 $\mu$ A 至 4mA
输入过驱电压	100mV
基准电压	2.5V
负载电容 ( $C_L$ )	15pF

#### 8.2.2 详细设计过程

在一般比较器应用中使用该器件时，请确定以下参数：

- 输入电压范围
- 最小过驱电压
- 输出和驱动电流
- 响应时间

##### 8.2.2.1 输入电压范围

在选择输入电压范围时，必须考虑输入共模电压范围 ( $V_{ICR}$ )。如果工作温度低于 25°C，则  $V_{ICR}$  的范围可以为 0V 至  $V_{CC} - 2.0V$ 。这可以将输入电压范围限制为  $V_{CC} - 2.0V$  至 0V。超出该范围的操作可能会产生不正确的比较结果。

以下是输入电压情况及其输出的列表：

1. 当 IN- 和 IN+ 都处于共模范围内时：
  - a. 如果 IN- 高于 IN+ 和失调电压，则输出为低电平，输出晶体管灌入电流
  - b. 如果 IN- 低于 IN+ 和失调电压，则输出为高阻抗，输出晶体管不导通
2. 当 IN- 高于共模且 IN+ 处于共模范围内时，输出为低电平，输出晶体管灌入电流
3. 当 IN+ 高于共模且 IN- 处于共模范围内时，输出为高阻抗，输出晶体管不导通
4. 当 IN- 和 IN+ 都高于共模时，输出为低电平，输出晶体管灌入电流

### 8.2.2.2 最小过驱电压

过驱电压是在失调电压 ( $V_{IO}$ ) 上比较器正负输入之间产生的差分电压。为实现准确比较，过驱动电压 ( $V_{OD}$ ) 应高于输入失调电压 ( $V_{IO}$ )。过驱动电压也可以决定比较器的响应时间，响应时间随着过驱动的增加而减小。图 8-2 和图 8-3 显示了与过驱动电压相关的正负响应时间。

### 8.2.2.3 输出和驱动电流

输出电流由负载/上拉电阻和逻辑/上拉电压决定。输出电流通过比较器产生输出低电压 ( $V_{OL}$ )。其中  $V_{OL}$  与输出电流成正比。可以参考 节 6.14 根据输出电流来确定  $V_{OL}$ 。

输出电流也会影响瞬态响应。请参阅 节 8.2.2.4 了解详情。

### 8.2.2.4 响应时间

响应时间是输入过驱动的函数。有关典型的响应时间，请参阅 节 8.2.3。上升和下降时间可以由负载电容 ( $C_L$ )、负载/上拉电阻 ( $R_{PULLUP}$ ) 和等效集电极-发射极电阻 ( $R_{CE}$ ) 确定。

- 上升时间 ( $\tau_R$ ) 约为  $\tau_R \sim R_{PULLUP} \times C_L$
- 下降时间 ( $\tau_F$ ) 约为  $\tau_F \sim R_{CE} \times C_L$ 
  - 可以通过获取所需温度下 节 6.14 线性区域的斜率或通过将  $V_{OL}$  除以  $I_{out}$  来确定  $R_{CE}$

### 8.2.3 应用曲线

以下曲线是在  $V_{CC}$  和  $V_{Logic}$  为 5V， $R_{PULLUP} = 5.1k\Omega$  以及采用 50pF 示波器探针的情况下生成的。



图 8-2. 各种过驱的响应时间 (正转换)



图 8-3. 各种过驱的响应时间 (负转换)

## 9 电源相关建议

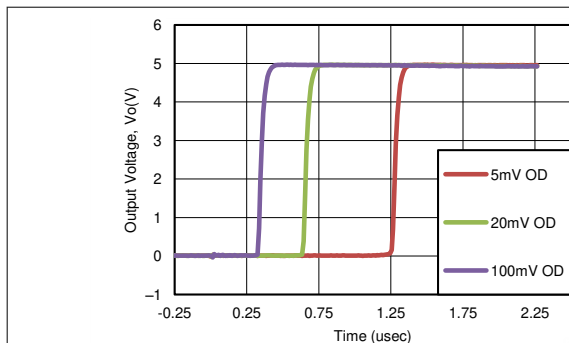
对于具有噪声或交流输入的快速响应和比较应用，TI 建议在电源引脚上使用一个旁路电容器来抑制电源电压的任何变化。这种变化会侵蚀比较器的输入共模范围，并产生不准确的比较结果。

## 10 布局

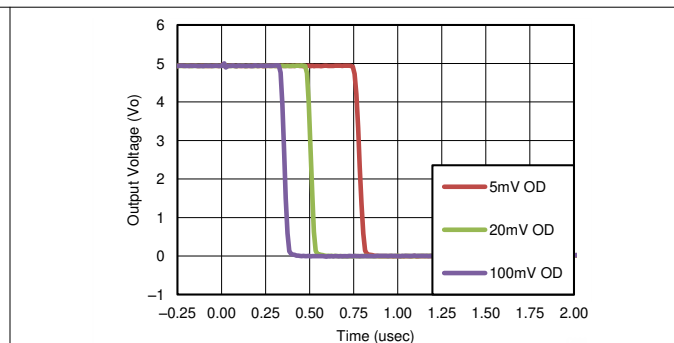
### 10.1 布局指南

对于没有迟滞的精确比较器应用，务必保持电源稳定，并将噪声和干扰降至最低。为此，最好在电源电压和接地之间添加一个旁路电容器。这应该在正电源和负电源（如果可用）上实现。如果不使用负电源，请勿在 IC 的 GND 引脚和系统接地之间放置电容器。

尽量减少输出和反相输入之间的耦合，以防止输出振荡。除非输出和反相输入引线之间存在  $V_{CC}$  或 GND 引线，否则请勿并行布置输出和反相输入引线，以减少耦合。向输入端添加串联电阻时，将电阻器放在靠近器件的位置。

### 10.2 布局示例



图 10-1. LM2903 布局示例

## 11 器件和文档支持

### 11.1 Receiving Notification of Documentation Updates

To receive notification of documentation updates, navigate to the device product folder on [ti.com](http://ti.com). Click on *Subscribe to updates* to register and receive a weekly digest of any product information that has changed. For change details, review the revision history included in any revised document.

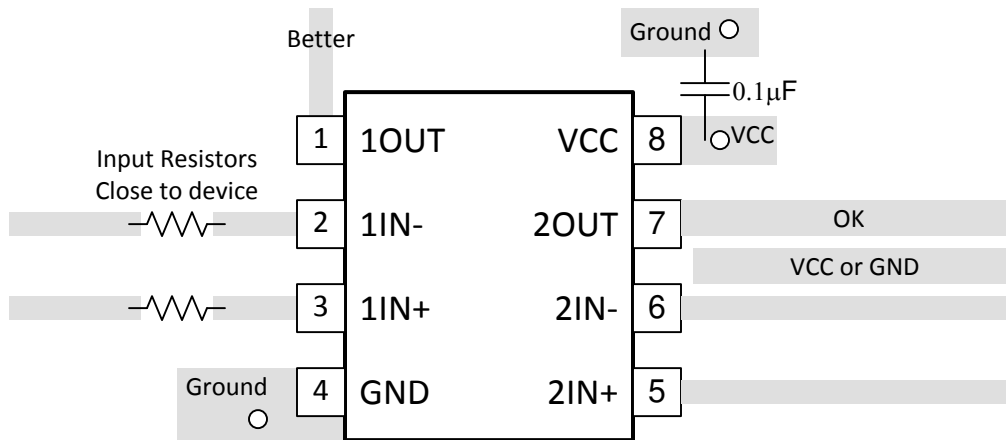
### 11.2 支持资源

[TI E2E™ 支持论坛](#)是工程师的重要参考资料，可直接从专家获得快速、经过验证的解答和设计帮助。搜索现有解答或提出自己的问题可获得所需的快速设计帮助。

链接的内容由各个贡献者“按原样”提供。这些内容并不构成 TI 技术规范，并且不一定反映 TI 的观点；请参阅 TI 的《使用条款》。

### 11.3 商标

TI E2E™ is a trademark of Texas Instruments.

所有商标均为其各自所有者的财产。

### 11.4 静电放电警告



静电放电 (ESD) 会损坏这个集成电路。德州仪器 (TI) 建议通过适当的预防措施处理所有集成电路。如果不遵守正确的处理和安装程序，可能会损坏集成电路。

ESD 的损坏小至导致微小的性能降级，大至整个器件故障。精密的集成电路可能更容易受到损坏，这是因为非常细微的参数更改都可能会导致器件与其发布的规格不相符。

### 11.5 术语表

[TI 术语表](#) 本术语表列出并解释了术语、首字母缩略词和定义。

## 12 机械、封装和可订购信息

以下页面包含机械、封装和可订购信息。这些信息是指定器件的最新可用数据。数据如有变更，恕不另行通知，且不会对此文档进行修订。如需获取此数据表的浏览器版本，请查阅左侧的导航栏。

**PACKAGING INFORMATION**

Orderable Device	Status (1)	Package Type	Package Drawing	Pins	Package Qty	Eco Plan (2)	Lead finish/ Ball material (6)	MSL Peak Temp (3)	Op Temp (°C)	Device Marking (4/5)	Samples
LM193DR	ACTIVE	SOIC	D	8	2500	RoHS & Green	NIPDAU	Level-1-260C-UNLIM	-55 to 125	LM193	<a href="#">Samples</a>
LM193DRG4	ACTIVE	SOIC	D	8	2500	RoHS & Green	NIPDAU	Level-1-260C-UNLIM	-55 to 125	LM193	<a href="#">Samples</a>
LM2903AVQDR	ACTIVE	SOIC	D	8	2500	RoHS & Green	NIPDAU	Level-1-260C-UNLIM	-40 to 125	L2903AV	<a href="#">Samples</a>
LM2903AVQDRG4	ACTIVE	SOIC	D	8	2500	RoHS & Green	NIPDAU	Level-1-260C-UNLIM	-40 to 125	L2903AV	<a href="#">Samples</a>
LM2903AVQPWR	ACTIVE	TSSOP	PW	8	2000	RoHS & Green	NIPDAU	Level-1-260C-UNLIM	-40 to 125	L2903AV	<a href="#">Samples</a>
LM2903AVQPWRG4	ACTIVE	TSSOP	PW	8	2000	RoHS & Green	NIPDAU	Level-1-260C-UNLIM	-40 to 125	L2903AV	<a href="#">Samples</a>
LM2903BIDDFR	ACTIVE	SOT-23-THIN	DDF	8	3000	RoHS & Green	NIPDAU	Level-1-260C-UNLIM	-40 to 125	2903B	<a href="#">Samples</a>
LM2903BIDGKR	ACTIVE	VSSOP	DGK	8	2500	RoHS & Green	NIPDAU	Level-1-260C-UNLIM	-40 to 125	903B	<a href="#">Samples</a>
LM2903BIDR	ACTIVE	SOIC	D	8	2500	RoHS & Green	NIPDAU	Level-1-260C-UNLIM	-40 to 125	L2903B	<a href="#">Samples</a>
LM2903BIDSGR	ACTIVE	WSON	DSG	8	3000	RoHS & Green	NIPDAU	Level-1-260C-UNLIM	-40 to 125	903B	<a href="#">Samples</a>
LM2903BIPWR	ACTIVE	TSSOP	PW	8	2000	RoHS & Green	NIPDAU	Level-1-260C-UNLIM	-40 to 125	L2903B	<a href="#">Samples</a>
LM2903D	NRND	SOIC	D	8	75	RoHS & Green	NIPDAU	Level-1-260C-UNLIM	-40 to 125	LM2903	
LM2903DE4	NRND	SOIC	D	8	75	RoHS & Green	NIPDAU	Level-1-260C-UNLIM	-40 to 125	LM2903	
LM2903DG4	NRND	SOIC	D	8	75	RoHS & Green	NIPDAU	Level-1-260C-UNLIM	-40 to 125	LM2903	
LM2903DGKR	ACTIVE	VSSOP	DGK	8	2500	RoHS & Green	NIPDAUAG   SN	Level-1-260C-UNLIM	-40 to 125	(MAP, MAS, MAU)	<a href="#">Samples</a>
LM2903DGKRG4	ACTIVE	VSSOP	DGK	8	2500	RoHS & Green	SN	Level-1-260C-UNLIM	-40 to 125	(MAP, MAS, MAU)	<a href="#">Samples</a>
LM2903DR	ACTIVE	SOIC	D	8	2500	RoHS & Green	NIPDAU   SN	Level-1-260C-UNLIM	-40 to 125	LM2903	<a href="#">Samples</a>
LM2903DRE4	LIFEBUY	SOIC	D	8	2500	RoHS & Green	NIPDAU	Level-1-260C-UNLIM	-40 to 125	LM2903	
LM2903DRG3	ACTIVE	SOIC	D	8	2500	RoHS & Green	SN	Level-1-260C-UNLIM	-40 to 125	LM2903	<a href="#">Samples</a>
LM2903DRG4	LIFEBUY	SOIC	D	8	2500	RoHS & Green	NIPDAU	Level-1-260C-UNLIM	-40 to 125	LM2903	
LM2903P	ACTIVE	PDIP	P	8	50	RoHS & Green	NIPDAU	N / A for Pkg Type	-40 to 125	LM2903P	<a href="#">Samples</a>

Orderable Device	Status (1)	Package Type	Package Drawing	Pins	Package Qty	Eco Plan (2)	Lead finish/ Ball material (6)	MSL Peak Temp (3)	Op Temp (°C)	Device Marking (4/5)	Samples
LM2903PSR	ACTIVE	SO	PS	8	2000	RoHS & Green	NIPDAU	Level-1-260C-UNLIM	-40 to 125	L2903	<a href="#">Samples</a>
LM2903PWR	ACTIVE	TSSOP	PW	8	2000	RoHS & Green	NIPDAU   SN	Level-1-260C-UNLIM	-40 to 125	L2903	<a href="#">Samples</a>
LM2903PWRG3	ACTIVE	TSSOP	PW	8	2000	RoHS & Green	SN	Level-1-260C-UNLIM	-40 to 125	L2903	<a href="#">Samples</a>
LM2903PWRG4	ACTIVE	TSSOP	PW	8	2000	RoHS & Green	NIPDAU	Level-1-260C-UNLIM	-40 to 125	L2903	<a href="#">Samples</a>
LM2903QD	ACTIVE	SOIC	D	8	75	RoHS & Green	NIPDAU	Level-1-260C-UNLIM	-40 to 125	2903Q	<a href="#">Samples</a>
LM2903QDG4	NRND	SOIC	D	8	75	RoHS & Green	NIPDAU	Level-1-260C-UNLIM	-40 to 125	2903Q	
LM2903QDRG4	ACTIVE	SOIC	D	8	2500	RoHS & Green	NIPDAU	Level-1-260C-UNLIM	-40 to 125	2903Q	<a href="#">Samples</a>
LM2903VQDR	ACTIVE	SOIC	D	8	2500	RoHS & Green	NIPDAU	Level-1-260C-UNLIM	-40 to 125	L2903V	<a href="#">Samples</a>
LM2903VQDRG4	ACTIVE	SOIC	D	8	2500	RoHS & Green	NIPDAU	Level-1-260C-UNLIM	-40 to 125	L2903V	<a href="#">Samples</a>
LM2903VQPWR	ACTIVE	TSSOP	PW	8	2000	RoHS & Green	NIPDAU	Level-1-260C-UNLIM	-40 to 125	L2903V	<a href="#">Samples</a>
LM2903VQPWRG4	ACTIVE	TSSOP	PW	8	2000	RoHS & Green	NIPDAU	Level-1-260C-UNLIM	-40 to 125	L2903V	<a href="#">Samples</a>
LM293AD	NRND	SOIC	D	8	75	RoHS & Green	NIPDAU	Level-1-260C-UNLIM	-25 to 85	LM293A	
LM293ADE4	NRND	SOIC	D	8	75	RoHS & Green	NIPDAU	Level-1-260C-UNLIM	-25 to 85	LM293A	
LM293ADGKR	ACTIVE	VSSOP	DGK	8	2500	RoHS & Green	NIPDAU   SN   NIPDAUAG	Level-1-260C-UNLIM	-25 to 85	(MDP, MDS, MDU)	<a href="#">Samples</a>
LM293ADGKRG4	ACTIVE	VSSOP	DGK	8	2500	RoHS & Green	SN	Level-1-260C-UNLIM	-25 to 85	(MDP, MDS, MDU)	<a href="#">Samples</a>
LM293ADR	ACTIVE	SOIC	D	8	2500	RoHS & Green	NIPDAU   SN	Level-1-260C-UNLIM	-25 to 85	LM293A	<a href="#">Samples</a>
LM293ADRG4	ACTIVE	SOIC	D	8	2500	RoHS & Green	NIPDAU	Level-1-260C-UNLIM	-25 to 85	LM293A	<a href="#">Samples</a>
LM293D	NRND	SOIC	D	8	75	RoHS & Green	NIPDAU	Level-1-260C-UNLIM	-25 to 85	LM293	
LM293DGKR	ACTIVE	VSSOP	DGK	8	2500	RoHS & Green	NIPDAU   SN   NIPDAUAG	Level-1-260C-UNLIM	-25 to 85	(MCP, MCS, MCU)	<a href="#">Samples</a>
LM293DGKRG4	ACTIVE	VSSOP	DGK	8	2500	RoHS & Green	SN	Level-1-260C-UNLIM	-25 to 85	(MCP, MCS, MCU)	<a href="#">Samples</a>
LM293DR	ACTIVE	SOIC	D	8	2500	RoHS & Green	NIPDAU   SN	Level-1-260C-UNLIM	-25 to 85	LM293	<a href="#">Samples</a>
LM293DRE4	LIFEBUY	SOIC	D	8	2500	RoHS & Green	NIPDAU	Level-1-260C-UNLIM	-25 to 85	LM293	



Orderable Device	Status (1)	Package Type	Package Drawing	Pins	Package Qty	Eco Plan (2)	Lead finish/ Ball material (6)	MSL Peak Temp (3)	Op Temp (°C)	Device Marking (4/5)	Samples
LM293DRG3	ACTIVE	SOIC	D	8	2500	RoHS & Green	SN	Level-1-260C-UNLIM	-25 to 85	LM293	<a href="#">Samples</a>
LM293DRG4	LIFEBUY	SOIC	D	8	2500	RoHS & Green	NIPDAU	Level-1-260C-UNLIM	-25 to 85	LM293	
LM293P	ACTIVE	PDIP	P	8	50	RoHS & Green	NIPDAU   SN	N / A for Pkg Type	-25 to 85	LM293P	<a href="#">Samples</a>
LM293PE4	LIFEBUY	PDIP	P	8	50	RoHS & Green	NIPDAU	N / A for Pkg Type	-25 to 85	LM293P	
LM393AD	NRND	SOIC	D	8	75	RoHS & Green	NIPDAU	Level-1-260C-UNLIM	0 to 70	LM393A	
LM393ADE4	NRND	SOIC	D	8	75	RoHS & Green	NIPDAU	Level-1-260C-UNLIM	0 to 70	LM393A	
LM393ADG4	NRND	SOIC	D	8	75	RoHS & Green	NIPDAU	Level-1-260C-UNLIM	0 to 70	LM393A	
LM393ADGKR	ACTIVE	VSSOP	DGK	8	2500	RoHS & Green	NIPDAU   NIPDAUAG	Level-1-260C-UNLIM	0 to 70	(M8P, M8S, M8U)	<a href="#">Samples</a>
LM393ADGKRG4	ACTIVE	VSSOP	DGK	8	2500	RoHS & Green	NIPDAU	Level-1-260C-UNLIM	0 to 70	(M8P, M8S, M8U)	<a href="#">Samples</a>
LM393ADR	ACTIVE	SOIC	D	8	2500	RoHS & Green	NIPDAU   SN	Level-1-260C-UNLIM	0 to 70	LM393A	<a href="#">Samples</a>
LM393ADRE4	LIFEBUY	SOIC	D	8	2500	RoHS & Green	NIPDAU	Level-1-260C-UNLIM	0 to 70	LM393A	
LM393ADRG4	LIFEBUY	SOIC	D	8	2500	RoHS & Green	NIPDAU	Level-1-260C-UNLIM	0 to 70	LM393A	
LM393AP	ACTIVE	PDIP	P	8	50	RoHS & Green	NIPDAU   SN	N / A for Pkg Type	0 to 70	LM393AP	<a href="#">Samples</a>
LM393APE4	LIFEBUY	PDIP	P	8	50	RoHS & Green	NIPDAU	N / A for Pkg Type	0 to 70	LM393AP	
LM393APSR	ACTIVE	SO	PS	8	2000	RoHS & Green	NIPDAU	Level-1-260C-UNLIM	0 to 70	L393A	<a href="#">Samples</a>
LM393APWR	ACTIVE	TSSOP	PW	8	2000	RoHS & Green	NIPDAU   SN	Level-1-260C-UNLIM	0 to 70	L393A	<a href="#">Samples</a>
LM393APWRE4	LIFEBUY	TSSOP	PW	8	2000	RoHS & Green	NIPDAU	Level-1-260C-UNLIM	0 to 70	L393A	
LM393APWRG4	LIFEBUY	TSSOP	PW	8	2000	RoHS & Green	NIPDAU	Level-1-260C-UNLIM	0 to 70	L393A	
LM393BIDDFR	ACTIVE	SOT-23-THIN	DDF	8	3000	RoHS & Green	NIPDAU	Level-1-260C-UNLIM	-40 to 85	393B	<a href="#">Samples</a>
LM393BIDGKR	ACTIVE	VSSOP	DGK	8	2500	RoHS & Green	NIPDAU	Level-1-260C-UNLIM	-40 to 85	393B	<a href="#">Samples</a>
LM393BIDR	ACTIVE	SOIC	D	8	2500	RoHS & Green	NIPDAU	Level-1-260C-UNLIM	-40 to 85	LM393B	<a href="#">Samples</a>
LM393BIDSGR	ACTIVE	WSON	DSG	8	3000	RoHS & Green	NIPDAU	Level-1-260C-UNLIM	-40 to 85	393B	<a href="#">Samples</a>
LM393BIPWR	ACTIVE	TSSOP	PW	8	2000	RoHS & Green	NIPDAU	Level-1-260C-UNLIM	-40 to 85	LM393B	<a href="#">Samples</a>
LM393D	NRND	SOIC	D	8	75	RoHS & Green	NIPDAU	Level-1-260C-UNLIM	0 to 70	LM393	
LM393DE4	NRND	SOIC	D	8	75	RoHS & Green	NIPDAU	Level-1-260C-UNLIM	0 to 70	LM393	

Orderable Device	Status (1)	Package Type	Package Drawing	Pins	Package Qty	Eco Plan (2)	Lead finish/ Ball material (6)	MSL Peak Temp (3)	Op Temp (°C)	Device Marking (4/5)	Samples
LM393DG4	NRND	SOIC	D	8	75	RoHS & Green	NIPDAU	Level-1-260C-UNLIM	0 to 70	LM393	
LM393DGKR	ACTIVE	VSSOP	DGK	8	2500	RoHS & Green	NIPDAU   SN   NIPDAUAG	Level-1-260C-UNLIM	0 to 70	(M9P, M9S, M9U)	<a href="#">Samples</a>
LM393DGKRG4	ACTIVE	VSSOP	DGK	8	2500	RoHS & Green	SN	Level-1-260C-UNLIM	0 to 70	(M9P, M9S, M9U)	<a href="#">Samples</a>
LM393DR	ACTIVE	SOIC	D	8	2500	RoHS & Green	NIPDAU   SN	Level-1-260C-UNLIM	0 to 70	LM393	<a href="#">Samples</a>
LM393DRE4	LIFEBUY	SOIC	D	8	2500	RoHS & Green	NIPDAU	Level-1-260C-UNLIM	0 to 70	LM393	
LM393DRG3	ACTIVE	SOIC	D	8	2500	RoHS & Green	SN	Level-1-260C-UNLIM	0 to 70	LM393	<a href="#">Samples</a>
LM393DRG4	LIFEBUY	SOIC	D	8	2500	RoHS & Green	NIPDAU	Level-1-260C-UNLIM	0 to 70	LM393	
LM393P	ACTIVE	PDIP	P	8	50	RoHS & Green	NIPDAU   SN	N / A for Pkg Type	0 to 70	LM393P	<a href="#">Samples</a>
LM393PE3	ACTIVE	PDIP	P	8	50	RoHS & Non-Green	SN	N / A for Pkg Type	0 to 70	LM393P	<a href="#">Samples</a>
LM393PE4	ACTIVE	PDIP	P	8	50	RoHS & Green	NIPDAU	N / A for Pkg Type	0 to 70	LM393P	<a href="#">Samples</a>
LM393PSR	ACTIVE	SO	PS	8	2000	RoHS & Green	NIPDAU	Level-1-260C-UNLIM	0 to 70	L393	<a href="#">Samples</a>
LM393PSRG4	ACTIVE	SO	PS	8	2000	RoHS & Green	NIPDAU	Level-1-260C-UNLIM	0 to 70	L393	<a href="#">Samples</a>
LM393PW	NRND	TSSOP	PW	8	150	RoHS & Green	NIPDAU	Level-1-260C-UNLIM	0 to 70	L393	
LM393PWG4	NRND	TSSOP	PW	8	150	RoHS & Green	NIPDAU	Level-1-260C-UNLIM	0 to 70	L393	
LM393PWR	ACTIVE	TSSOP	PW	8	2000	RoHS & Green	NIPDAU   SN	Level-1-260C-UNLIM	0 to 70	L393	<a href="#">Samples</a>
LM393PWRG3	ACTIVE	TSSOP	PW	8	2000	RoHS & Green	SN	Level-1-260C-UNLIM	0 to 70	L393	<a href="#">Samples</a>
LM393PWRG4	ACTIVE	TSSOP	PW	8	2000	RoHS & Green	NIPDAU	Level-1-260C-UNLIM	0 to 70	L393	<a href="#">Samples</a>

(1) The marketing status values are defined as follows:

**ACTIVE:** Product device recommended for new designs.

**LIFEBUY:** TI has announced that the device will be discontinued, and a lifetime-buy period is in effect.

**NRND:** Not recommended for new designs. Device is in production to support existing customers, but TI does not recommend using this part in a new design.

**PREVIEW:** Device has been announced but is not in production. Samples may or may not be available.

**OBSELETE:** TI has discontinued the production of the device.

(2) **RoHS:** TI defines "RoHS" to mean semiconductor products that are compliant with the current EU RoHS requirements for all 10 RoHS substances, including the requirement that RoHS substance do not exceed 0.1% by weight in homogeneous materials. Where designed to be soldered at high temperatures, "RoHS" products are suitable for use in specified lead-free processes. TI may reference these types of products as "Pb-Free".

**RoHS Exempt:** TI defines "RoHS Exempt" to mean products that contain lead but are compliant with EU RoHS pursuant to a specific EU RoHS exemption.

**Green:** TI defines "Green" to mean the content of Chlorine (Cl) and Bromine (Br) based flame retardants meet JS709B low halogen requirements of  $\leq 1000$ ppm threshold. Antimony trioxide based flame retardants must also meet the  $\leq 1000$ ppm threshold requirement.

(3) MSL, Peak Temp. - The Moisture Sensitivity Level rating according to the JEDEC industry standard classifications, and peak solder temperature.

(4) There may be additional marking, which relates to the logo, the lot trace code information, or the environmental category on the device.

(5) Multiple Device Markings will be inside parentheses. Only one Device Marking contained in parentheses and separated by a "~" will appear on a device. If a line is indented then it is a continuation of the previous line and the two combined represent the entire Device Marking for that device.

(6) Lead finish/Ball material - Orderable Devices may have multiple material finish options. Finish options are separated by a vertical ruled line. Lead finish/Ball material values may wrap to two lines if the finish value exceeds the maximum column width.

**Important Information and Disclaimer:** The information provided on this page represents TI's knowledge and belief as of the date that it is provided. TI bases its knowledge and belief on information provided by third parties, and makes no representation or warranty as to the accuracy of such information. Efforts are underway to better integrate information from third parties. TI has taken and continues to take reasonable steps to provide representative and accurate information but may not have conducted destructive testing or chemical analysis on incoming materials and chemicals. TI and TI suppliers consider certain information to be proprietary, and thus CAS numbers and other limited information may not be available for release.

In no event shall TI's liability arising out of such information exceed the total purchase price of the TI part(s) at issue in this document sold by TI to Customer on an annual basis.

**OTHER QUALIFIED VERSIONS OF LM2903, LM2903B, LM293 :**

● Automotive : [LM2903-Q1](#), [LM2903B-Q1](#)

● Enhanced Product : [LM293-EP](#)

NOTE: Qualified Version Definitions:

● Automotive - Q100 devices qualified for high-reliability automotive applications targeting zero defects

● Enhanced Product - Supports Defense, Aerospace and Medical Applications

**TAPE AND REEL INFORMATION**

**QUADRANT ASSIGNMENTS FOR PIN 1 ORIENTATION IN TAPE**

\*All dimensions are nominal

Device	Package Type	Package Drawing	Pins	SPQ	Reel Diameter (mm)	Reel Width W1 (mm)	A0 (mm)	B0 (mm)	K0 (mm)	P1 (mm)	W (mm)	Pin1 Quadrant
LM193DR	SOIC	D	8	2500	330.0	12.4	6.4	5.2	2.1	8.0	12.0	Q1
LM2903AVQDR	SOIC	D	8	2500	330.0	12.5	6.4	5.2	2.1	8.0	12.0	Q1
LM2903AVQDR	SOIC	D	8	2500	330.0	12.4	6.4	5.2	2.1	8.0	12.0	Q1
LM2903AVQDRG4	SOIC	D	8	2500	330.0	12.4	6.4	5.2	2.1	8.0	12.0	Q1
LM2903AVQPWR	TSSOP	PW	8	2000	330.0	12.4	7.0	3.6	1.6	8.0	12.0	Q1
LM2903AVQPWRG4	TSSOP	PW	8	2000	330.0	12.4	7.0	3.6	1.6	8.0	12.0	Q1
LM2903BIDDFR	SOT-23-THIN	DDF	8	3000	180.0	8.4	3.2	3.2	1.4	4.0	8.0	Q3
LM2903BIDGKR	VSSOP	DGK	8	2500	330.0	12.4	5.3	3.4	1.4	8.0	12.0	Q1
LM2903BIDR	SOIC	D	8	2500	330.0	12.4	6.4	5.2	2.1	8.0	12.0	Q1
LM2903BIDSGR	WSO	DSG	8	3000	180.0	8.4	2.3	2.3	1.15	4.0	8.0	Q2
LM2903BIPWR	TSSOP	PW	8	2000	330.0	12.4	7.0	3.6	1.6	8.0	12.0	Q1
LM2903DGKR	VSSOP	DGK	8	2500	330.0	12.4	5.3	3.4	1.4	8.0	12.0	Q1
LM2903DGKR	VSSOP	DGK	8	2500	330.0	12.4	5.3	3.4	1.4	8.0	12.0	Q1
LM2903DR	SOIC	D	8	2500	330.0	12.4	6.4	5.2	2.1	8.0	12.0	Q1
LM2903DR	SOIC	D	8	2500	330.0	12.8	6.4	5.2	2.1	8.0	12.0	Q1

Device	Package Type	Package Drawing	Pins	SPQ	Reel Diameter (mm)	Reel Width W1 (mm)	A0 (mm)	B0 (mm)	K0 (mm)	P1 (mm)	W (mm)	Pin1 Quadrant
LM2903DR	SOIC	D	8	2500	330.0	12.4	6.4	5.2	2.1	8.0	12.0	Q1
LM2903DRG3	SOIC	D	8	2500	330.0	12.8	6.4	5.2	2.1	8.0	12.0	Q1
LM2903DRG4	SOIC	D	8	2500	330.0	12.4	6.4	5.2	2.1	8.0	12.0	Q1
LM2903DRG4	SOIC	D	8	2500	330.0	12.4	6.4	5.2	2.1	8.0	12.0	Q1
LM2903PSR	SO	PS	8	2000	330.0	16.4	8.35	6.6	2.4	12.0	16.0	Q1
LM2903PWR	TSSOP	PW	8	2000	330.0	12.4	7.0	3.6	1.6	8.0	12.0	Q1
LM2903PWR	TSSOP	PW	8	2000	330.0	12.4	7.0	3.6	1.6	8.0	12.0	Q1
LM2903PWR	TSSOP	PW	8	2000	330.0	12.4	7.0	3.6	1.6	8.0	12.0	Q1
LM2903PWRG3	TSSOP	PW	8	2000	330.0	12.4	7.0	3.6	1.6	8.0	12.0	Q1
LM2903PWRG4	TSSOP	PW	8	2000	330.0	12.4	7.0	3.6	1.6	8.0	12.0	Q1
LM2903QDRG4	SOIC	D	8	2500	330.0	12.4	6.4	5.2	2.1	8.0	12.0	Q1
LM2903VQDR	SOIC	D	8	2500	330.0	12.5	6.4	5.2	2.1	8.0	12.0	Q1
LM2903VQDR	SOIC	D	8	2500	330.0	12.4	6.4	5.2	2.1	8.0	12.0	Q1
LM2903VQDRG4	SOIC	D	8	2500	330.0	12.4	6.4	5.2	2.1	8.0	12.0	Q1
LM2903VQPWR	TSSOP	PW	8	2000	330.0	12.4	7.0	3.6	1.6	8.0	12.0	Q1
LM2903VQPWR	TSSOP	PW	8	2000	330.0	12.4	7.0	3.6	1.6	8.0	12.0	Q1
LM2903VQPWRG4	TSSOP	PW	8	2000	330.0	12.4	7.0	3.6	1.6	8.0	12.0	Q1
LM293ADGKR	VSSOP	DGK	8	2500	330.0	12.4	5.3	3.3	1.3	8.0	12.0	Q1
LM293ADGKR	VSSOP	DGK	8	2500	330.0	12.4	5.3	3.4	1.4	8.0	12.0	Q1
LM293ADGKR	VSSOP	DGK	8	2500	330.0	12.4	5.3	3.4	1.4	8.0	12.0	Q1
LM293ADGKR	VSSOP	DGK	8	2500	330.0	12.4	5.3	3.4	1.4	8.0	12.0	Q1
LM293ADR	SOIC	D	8	2500	330.0	12.4	6.4	5.2	2.1	8.0	12.0	Q1
LM293ADR	SOIC	D	8	2500	330.0	12.8	6.4	5.2	2.1	8.0	12.0	Q1
LM293ADR	SOIC	D	8	2500	330.0	12.4	6.4	5.2	2.1	8.0	12.0	Q1
LM293ADRG4	SOIC	D	8	2500	330.0	12.4	6.4	5.2	2.1	8.0	12.0	Q1
LM293ADRG4	SOIC	D	8	2500	330.0	12.4	6.4	5.2	2.1	8.0	12.0	Q1
LM293ADRG4	SOIC	D	8	2500	330.0	12.4	6.4	5.2	2.1	8.0	12.0	Q1
LM293ADRG4	SOIC	D	8	2500	330.0	12.4	6.4	5.2	2.1	8.0	12.0	Q1
LM293ADRG4	SOIC	D	8	2500	330.0	12.4	6.4	5.2	2.1	8.0	12.0	Q1
LM293ADRG4	SOIC	D	8	2500	330.0	12.4	6.4	5.2	2.1	8.0	12.0	Q1
LM293DGKR	VSSOP	DGK	8	2500	330.0	12.4	5.3	3.4	1.4	8.0	12.0	Q1
LM293DGKR	VSSOP	DGK	8	2500	330.0	12.4	5.3	3.4	1.4	8.0	12.0	Q1
LM293DR	SOIC	D	8	2500	330.0	12.8	6.4	5.2	2.1	8.0	12.0	Q1
LM293DR	SOIC	D	8	2500	330.0	12.4	6.4	5.2	2.1	8.0	12.0	Q1
LM293DR	SOIC	D	8	2500	330.0	12.4	6.4	5.2	2.1	8.0	12.0	Q1
LM293DRG3	SOIC	D	8	2500	330.0	12.8	6.4	5.2	2.1	8.0	12.0	Q1
LM293DRG4	SOIC	D	8	2500	330.0	12.4	6.4	5.2	2.1	8.0	12.0	Q1
LM293DRG4	SOIC	D	8	2500	330.0	12.4	6.4	5.2	2.1	8.0	12.0	Q1
LM393ADGKR	VSSOP	DGK	8	2500	330.0	12.4	5.3	3.3	1.3	8.0	12.0	Q1
LM393ADGKR	VSSOP	DGK	8	2500	330.0	12.4	5.3	3.4	1.4	8.0	12.0	Q1
LM393ADGKR	VSSOP	DGK	8	2500	330.0	12.4	5.3	3.4	1.4	8.0	12.0	Q1
LM393ADR	SOIC	D	8	2500	330.0	12.8	6.4	5.2	2.1	8.0	12.0	Q1
LM393ADR	SOIC	D	8	2500	330.0	12.4	6.4	5.2	2.1	8.0	12.0	Q1

Device	Package Type	Package Drawing	Pins	SPQ	Reel Diameter (mm)	Reel Width W1 (mm)	A0 (mm)	B0 (mm)	K0 (mm)	P1 (mm)	W (mm)	Pin1 Quadrant
LM393ADR	SOIC	D	8	2500	330.0	12.4	6.4	5.2	2.1	8.0	12.0	Q1
LM393ADRG4	SOIC	D	8	2500	330.0	12.4	6.4	5.2	2.1	8.0	12.0	Q1
LM393ADRG4	SOIC	D	8	2500	330.0	12.4	6.4	5.2	2.1	8.0	12.0	Q1
LM393APSR	SO	PS	8	2000	330.0	16.4	8.35	6.6	2.4	12.0	16.0	Q1
LM393APWR	TSSOP	PW	8	2000	330.0	12.4	7.0	3.6	1.6	8.0	12.0	Q1
LM393APWR	TSSOP	PW	8	2000	330.0	12.4	7.0	3.6	1.6	8.0	12.0	Q1
LM393APWR	TSSOP	PW	8	2000	330.0	12.4	7.0	3.6	1.6	8.0	12.0	Q1
LM393APWRG4	TSSOP	PW	8	2000	330.0	12.4	7.0	3.6	1.6	8.0	12.0	Q1
LM393BIDDFR	SOT-23-THIN	DDF	8	3000	180.0	8.4	3.2	3.2	1.4	4.0	8.0	Q3
LM393BIDGKR	VSSOP	DGK	8	2500	330.0	12.4	5.3	3.4	1.4	8.0	12.0	Q1
LM393BIDR	SOIC	D	8	2500	330.0	12.4	6.4	5.2	2.1	8.0	12.0	Q1
LM393BIDSGR	WSON	DSG	8	3000	180.0	8.4	2.3	2.3	1.15	4.0	8.0	Q2
LM393BIPWR	TSSOP	PW	8	2000	330.0	12.4	7.0	3.6	1.6	8.0	12.0	Q1
LM393DGKR	VSSOP	DGK	8	2500	330.0	12.4	5.3	3.4	1.4	8.0	12.0	Q1
LM393DGKR	VSSOP	DGK	8	2500	330.0	12.4	5.3	3.4	1.4	8.0	12.0	Q1
LM393DR	SOIC	D	8	2500	330.0	12.4	6.4	5.2	2.1	8.0	12.0	Q1
LM393DR	SOIC	D	8	2500	330.0	12.4	6.4	5.2	2.1	8.0	12.0	Q1
LM393DRG3	SOIC	D	8	2500	330.0	15.4	6.4	5.2	2.1	8.0	12.0	Q1
LM393DRG3	SOIC	D	8	2500	330.0	12.8	6.4	5.2	2.1	8.0	12.0	Q1
LM393DRG4	SOIC	D	8	2500	330.0	12.4	6.4	5.2	2.1	8.0	12.0	Q1
LM393DRG4	SOIC	D	8	2500	330.0	12.4	6.4	5.2	2.1	8.0	12.0	Q1
LM393PSR	SO	PS	8	2000	330.0	16.4	8.35	6.6	2.4	12.0	16.0	Q1
LM393PWR	TSSOP	PW	8	2000	330.0	12.4	7.0	3.6	1.6	8.0	12.0	Q1
LM393PWR	TSSOP	PW	8	2000	330.0	12.4	7.0	3.6	1.6	8.0	12.0	Q1
LM393PWRG3	TSSOP	PW	8	2000	330.0	12.4	7.0	3.6	1.6	8.0	12.0	Q1
LM393PWRG4	TSSOP	PW	8	2000	330.0	12.4	7.0	3.6	1.6	8.0	12.0	Q1

**TAPE AND REEL BOX DIMENSIONS**

\*All dimensions are nominal

Device	Package Type	Package Drawing	Pins	SPQ	Length (mm)	Width (mm)	Height (mm)
LM193DR	SOIC	D	8	2500	350.0	350.0	43.0
LM2903AVQDR	SOIC	D	8	2500	340.5	336.1	25.0
LM2903AVQDR	SOIC	D	8	2500	340.5	338.1	20.6
LM2903AVQDRG4	SOIC	D	8	2500	340.5	338.1	20.6
LM2903AVQPWR	TSSOP	PW	8	2000	356.0	356.0	35.0
LM2903AVQPWRG4	TSSOP	PW	8	2000	356.0	356.0	35.0
LM2903BIDDFR	SOT-23-THIN	DDF	8	3000	210.0	185.0	35.0
LM2903BIDGKR	VSSOP	DGK	8	2500	366.0	364.0	50.0
LM2903BIDR	SOIC	D	8	2500	340.5	336.1	25.0
LM2903BIDSGR	WSON	DSG	8	3000	210.0	185.0	35.0
LM2903BIPWR	TSSOP	PW	8	2000	356.0	356.0	35.0
LM2903DGKR	VSSOP	DGK	8	2500	364.0	364.0	27.0
LM2903DGKR	VSSOP	DGK	8	2500	366.0	364.0	50.0
LM2903DR	SOIC	D	8	2500	340.5	338.1	20.6
LM2903DR	SOIC	D	8	2500	364.0	364.0	27.0
LM2903DR	SOIC	D	8	2500	340.5	338.1	20.6
LM2903DRG3	SOIC	D	8	2500	364.0	364.0	27.0
LM2903DRG4	SOIC	D	8	2500	340.5	336.1	25.0

Device	Package Type	Package Drawing	Pins	SPQ	Length (mm)	Width (mm)	Height (mm)
LM2903DRG4	SOIC	D	8	2500	340.5	338.1	20.6
LM2903PSR	SO	PS	8	2000	356.0	356.0	35.0
LM2903PWR	TSSOP	PW	8	2000	364.0	364.0	27.0
LM2903PWR	TSSOP	PW	8	2000	356.0	356.0	35.0
LM2903PWR	TSSOP	PW	8	2000	356.0	356.0	35.0
LM2903PWRG3	TSSOP	PW	8	2000	364.0	364.0	27.0
LM2903PWRG4	TSSOP	PW	8	2000	356.0	356.0	35.0
LM2903QDRG4	SOIC	D	8	2500	350.0	350.0	43.0
LM2903VQDR	SOIC	D	8	2500	340.5	338.1	20.6
LM2903VQDR	SOIC	D	8	2500	340.5	338.1	20.6
LM2903VQDRG4	SOIC	D	8	2500	340.5	338.1	20.6
LM2903VQPWR	TSSOP	PW	8	2000	356.0	356.0	35.0
LM2903VQPWR	TSSOP	PW	8	2000	356.0	356.0	35.0
LM2903VQPWRG4	TSSOP	PW	8	2000	356.0	356.0	35.0
LM293ADGKR	VSSOP	DGK	8	2500	370.0	355.0	55.0
LM293ADGKR	VSSOP	DGK	8	2500	364.0	364.0	27.0
LM293ADGKR	VSSOP	DGK	8	2500	358.0	335.0	35.0
LM293ADGKR	VSSOP	DGK	8	2500	366.0	364.0	50.0
LM293ADR	SOIC	D	8	2500	340.5	338.1	20.6
LM293ADR	SOIC	D	8	2500	364.0	364.0	27.0
LM293ADR	SOIC	D	8	2500	340.5	336.1	25.0
LM293ADRG4	SOIC	D	8	2500	340.5	336.1	25.0
LM293ADRG4	SOIC	D	8	2500	356.0	356.0	35.0
LM293ADRG4	SOIC	D	8	2500	356.0	356.0	35.0
LM293ADRG4	SOIC	D	8	2500	340.5	338.1	20.6
LM293DGKR	VSSOP	DGK	8	2500	364.0	364.0	27.0
LM293DGKR	VSSOP	DGK	8	2500	366.0	364.0	50.0
LM293DR	SOIC	D	8	2500	364.0	364.0	27.0
LM293DR	SOIC	D	8	2500	356.0	356.0	35.0
LM293DR	SOIC	D	8	2500	356.0	356.0	35.0
LM293DRG3	SOIC	D	8	2500	364.0	364.0	27.0
LM293DRG4	SOIC	D	8	2500	340.5	336.1	25.0
LM293DRG4	SOIC	D	8	2500	340.5	338.1	20.6
LM393ADGKR	VSSOP	DGK	8	2500	346.0	346.0	35.0
LM393ADGKR	VSSOP	DGK	8	2500	364.0	364.0	27.0
LM393ADGKR	VSSOP	DGK	8	2500	358.0	335.0	35.0
LM393ADR	SOIC	D	8	2500	364.0	364.0	27.0
LM393ADR	SOIC	D	8	2500	340.5	338.1	20.6
LM393ADR	SOIC	D	8	2500	340.5	336.1	25.0
LM393ADRG4	SOIC	D	8	2500	340.5	338.1	20.6
LM393ADRG4	SOIC	D	8	2500	340.5	336.1	25.0
LM393APSR	SO	PS	8	2000	356.0	356.0	35.0
LM393APWR	TSSOP	PW	8	2000	356.0	356.0	35.0



Device	Package Type	Package Drawing	Pins	SPQ	Length (mm)	Width (mm)	Height (mm)
LM393APWR	TSSOP	PW	8	2000	356.0	356.0	35.0
LM393APWR	TSSOP	PW	8	2000	364.0	364.0	27.0
LM393APWRG4	TSSOP	PW	8	2000	356.0	356.0	35.0
LM393BIDDFR	SOT-23-THIN	DDF	8	3000	210.0	185.0	35.0
LM393BIDGKR	VSSOP	DGK	8	2500	366.0	364.0	50.0
LM393BIDR	SOIC	D	8	2500	340.5	336.1	25.0
LM393BIDSGR	WSON	DSG	8	3000	210.0	185.0	35.0
LM393BIPWR	TSSOP	PW	8	2000	356.0	356.0	35.0
LM393DGKR	VSSOP	DGK	8	2500	366.0	364.0	50.0
LM393DGKR	VSSOP	DGK	8	2500	364.0	364.0	27.0
LM393DR	SOIC	D	8	2500	340.5	338.1	25.0
LM393DR	SOIC	D	8	2500	340.5	338.1	20.6
LM393DRG3	SOIC	D	8	2500	333.2	345.9	28.6
LM393DRG3	SOIC	D	8	2500	364.0	364.0	27.0
LM393DRG4	SOIC	D	8	2500	340.5	338.1	20.6
LM393DRG4	SOIC	D	8	2500	340.5	336.1	25.0
LM393PSR	SO	PS	8	2000	356.0	356.0	35.0
LM393PWR	TSSOP	PW	8	2000	356.0	356.0	35.0
LM393PWR	TSSOP	PW	8	2000	364.0	364.0	27.0
LM393PWRG3	TSSOP	PW	8	2000	364.0	364.0	27.0
LM393PWRG4	TSSOP	PW	8	2000	356.0	356.0	35.0

**TUBE**

\*All dimensions are nominal

Device	Package Name	Package Type	Pins	SPQ	L (mm)	W (mm)	T (µm)	B (mm)
LM2903D	D	SOIC	8	75	507	8	3940	4.32
LM2903D	D	SOIC	8	75	506.6	8	3940	4.32
LM2903DE4	D	SOIC	8	75	507	8	3940	4.32
LM2903DE4	D	SOIC	8	75	506.6	8	3940	4.32
LM2903DG4	D	SOIC	8	75	507	8	3940	4.32
LM2903DG4	D	SOIC	8	75	506.6	8	3940	4.32
LM2903P	P	PDIP	8	50	506	13.97	11230	4.32
LM2903QD	D	SOIC	8	75	505.46	6.76	3810	4
LM2903QDG4	D	SOIC	8	75	505.46	6.76	3810	4
LM293AD	D	SOIC	8	75	506.6	8	3940	4.32
LM293AD	D	SOIC	8	75	507	8	3940	4.32
LM293ADE4	D	SOIC	8	75	506.6	8	3940	4.32
LM293ADE4	D	SOIC	8	75	507	8	3940	4.32
LM293D	D	SOIC	8	75	506.6	8	3940	4.32
LM293D	D	SOIC	8	75	507	8	3940	4.32
LM293P	P	PDIP	8	50	506.1	9	600	5.4
LM293P	P	PDIP	8	50	506	13.97	11230	4.32
LM293PE4	P	PDIP	8	50	506.1	9	600	5.4
LM293PE4	P	PDIP	8	50	506	13.97	11230	4.32
LM393AD	D	SOIC	8	75	506.6	8	3940	4.32
LM393AD	D	SOIC	8	75	507	8	3940	4.32
LM393ADE4	D	SOIC	8	75	507	8	3940	4.32
LM393ADE4	D	SOIC	8	75	506.6	8	3940	4.32
LM393ADG4	D	SOIC	8	75	507	8	3940	4.32
LM393ADG4	D	SOIC	8	75	506.6	8	3940	4.32
LM393AP	P	PDIP	8	50	506.1	9	600	5.4
LM393AP	P	PDIP	8	50	506	13.97	11230	4.32
LM393APE4	P	PDIP	8	50	506	13.97	11230	4.32
LM393APE4	P	PDIP	8	50	506.1	9	600	5.4

Device	Package Name	Package Type	Pins	SPQ	L (mm)	W (mm)	T (µm)	B (mm)
LM393D	D	SOIC	8	75	506.6	8	3940	4.32
LM393D	D	SOIC	8	75	507	8	3940	4.32
LM393DE4	D	SOIC	8	75	506.6	8	3940	4.32
LM393DE4	D	SOIC	8	75	507	8	3940	4.32
LM393DG4	D	SOIC	8	75	507	8	3940	4.32
LM393DG4	D	SOIC	8	75	506.6	8	3940	4.32
LM393P	P	PDIP	8	50	506.1	9	600	5.4
LM393P	P	PDIP	8	50	506	13.97	11230	4.32
LM393PE3	P	PDIP	8	50	506.1	9	600	5.4
LM393PE4	P	PDIP	8	50	506	13.97	11230	4.32
LM393PW	PW	TSSOP	8	150	530	10.2	3600	3.5
LM393PWG4	PW	TSSOP	8	150	530	10.2	3600	3.5



D0008A

# PACKAGE OUTLINE

SOIC - 1.75 mm max height

SMALL OUTLINE INTEGRATED CIRCUIT



4214825/C 02/2019

### NOTES:

- Linear dimensions are in inches [millimeters]. Dimensions in parenthesis are for reference only. Controlling dimensions are in inches. Dimensioning and tolerancing per ASME Y14.5M.
- This drawing is subject to change without notice.
- This dimension does not include mold flash, protrusions, or gate burrs. Mold flash, protrusions, or gate burrs shall not exceed .006 [0.15] per side.
- This dimension does not include interlead flash.
- Reference JEDEC registration MS-012, variation AA.

# EXAMPLE BOARD LAYOUT

D0008A

SOIC - 1.75 mm max height

SMALL OUTLINE INTEGRATED CIRCUIT



LAND PATTERN EXAMPLE  
EXPOSED METAL SHOWN  
SCALE:8X



SOLDER MASK DETAILS

4214825/C 02/2019

NOTES: (continued)

- 6. Publication IPC-7351 may have alternate designs.
- 7. Solder mask tolerances between and around signal pads can vary based on board fabrication site.

# EXAMPLE STENCIL DESIGN

D0008A

SOIC - 1.75 mm max height

SMALL OUTLINE INTEGRATED CIRCUIT



SOLDER PASTE EXAMPLE  
BASED ON .005 INCH [0.125 MM] THICK STENCIL  
SCALE:8X

4214825/C 02/2019

NOTES: (continued)

8. Laser cutting apertures with trapezoidal walls and rounded corners may offer better paste release. IPC-7525 may have alternate design recommendations.
9. Board assembly site may have different recommendations for stencil design.

# MECHANICAL DATA

PS (R-PDSO-G8)

PLASTIC SMALL-OUTLINE PACKAGE



- NOTES:
- A. All linear dimensions are in millimeters.
  - B. This drawing is subject to change without notice.
  - C. Body dimensions do not include mold flash or protrusion, not to exceed 0,15.

PS (R-PDSO-G8)

PLASTIC SMALL OUTLINE



- NOTES:
- A. All linear dimensions are in millimeters.
  - B. This drawing is subject to change without notice.
  - C. Publication IPC-7351 is recommended for alternate designs.
  - D. Laser cutting apertures with trapezoidal walls and also rounding corners will offer better paste release. Customers should contact their board assembly site for stencil design recommendations. Refer to IPC-7525 for other stencil recommendations.
  - E. Customers should contact their board fabrication site for solder mask tolerances between and around signal pads.



P (R-PDIP-T8)

PLASTIC DUAL-IN-LINE PACKAGE



- NOTES:
- A. All linear dimensions are in inches (millimeters).
  - B. This drawing is subject to change without notice.
  - C. Falls within JEDEC MS-001 variation BA.

DGK (S-PDSO-G8)

PLASTIC SMALL-OUTLINE PACKAGE



4073329/E 05/06

- NOTES:
- A. All linear dimensions are in millimeters.
  - B. This drawing is subject to change without notice.
  - C. Body length does not include mold flash, protrusions, or gate burrs. Mold flash, protrusions, or gate burrs shall not exceed 0.15 per end.
  - D. Body width does not include interlead flash. Interlead flash shall not exceed 0.50 per side.
  - E. Falls within JEDEC MO-187 variation AA, except interlead flash.



- NOTES:
- A. All linear dimensions are in millimeters.
  - B. This drawing is subject to change without notice.
  - C. Publication IPC-7351 is recommended for alternate designs.
  - D. Laser cutting apertures with trapezoidal walls and also rounding corners will offer better paste release. Customers should contact their board assembly site for stencil design recommendations. Refer to IPC-7525 for other stencil recommendations.
  - E. Customers should contact their board fabrication site for solder mask tolerances between and around signal pads.

## GENERIC PACKAGE VIEW

**DSG 8**

**WSON - 0.8 mm max height**

2 x 2, 0.5 mm pitch

PLASTIC SMALL OUTLINE - NO LEAD

This image is a representation of the package family, actual package may vary.  
Refer to the product data sheet for package details.



4224783/A

# DSG0008A



# PACKAGE OUTLINE

## WSON - 0.8 mm max height

PLASTIC SMALL OUTLINE - NO LEAD



ALTERNATIVE TERMINAL SHAPE TYPICAL



SIDE WALL METAL THICKNESS DIM A	
OPTION 1	OPTION 2
0.1	0.2

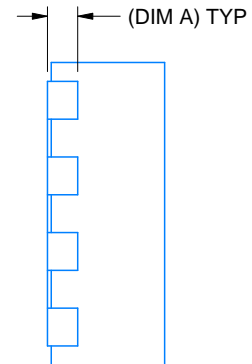

4218900/E 08/2022

### NOTES:

1. All linear dimensions are in millimeters. Any dimensions in parenthesis are for reference only. Dimensioning and tolerancing per ASME Y14.5M.
2. This drawing is subject to change without notice.
3. The package thermal pad must be soldered to the printed circuit board for thermal and mechanical performance.



# EXAMPLE STENCIL DESIGN

DSG0008A

WSON - 0.8 mm max height

PLASTIC SMALL OUTLINE - NO LEAD



SOLDER PASTE EXAMPLE  
BASED ON 0.125 mm THICK STENCIL

EXPOSED PAD 9:  
87% PRINTED SOLDER COVERAGE BY AREA UNDER PACKAGE  
SCALE:25X

4218900/E 08/2022

NOTES: (continued)

6. Laser cutting apertures with trapezoidal walls and rounded corners may offer better paste release. IPC-7525 may have alternate design recommendations.

PW0008A



PACKAGE OUTLINE  
TSSOP - 1.2 mm max height

SMALL OUTLINE PACKAGE



4221848/A 02/2015

NOTES:

1. All linear dimensions are in millimeters. Any dimensions in parenthesis are for reference only. Dimensioning and tolerancing per ASME Y14.5M.
2. This drawing is subject to change without notice.
3. This dimension does not include mold flash, protrusions, or gate burrs. Mold flash, protrusions, or gate burrs shall not exceed 0.15 mm per side.
4. This dimension does not include interlead flash. Interlead flash shall not exceed 0.25 mm per side.
5. Reference JEDEC registration MO-153, variation AA.



# EXAMPLE BOARD LAYOUT

PW0008A

TSSOP - 1.2 mm max height

SMALL OUTLINE PACKAGE



LAND PATTERN EXAMPLE  
SCALE:10X



SOLDER MASK DETAILS  
NOT TO SCALE

4221848/A 02/2015

NOTES: (continued)

- 6. Publication IPC-7351 may have alternate designs.
- 7. Solder mask tolerances between and around signal pads can vary based on board fabrication site.

# EXAMPLE STENCIL DESIGN

PW0008A

TSSOP - 1.2 mm max height

SMALL OUTLINE PACKAGE



SOLDER PASTE EXAMPLE  
BASED ON 0.125 mm THICK STENCIL  
SCALE:10X

4221848/A 02/2015

NOTES: (continued)

8. Laser cutting apertures with trapezoidal walls and rounded corners may offer better paste release. IPC-7525 may have alternate design recommendations.
9. Board assembly site may have different recommendations for stencil design.

# DDF0008A



# PACKAGE OUTLINE

## SOT-23 - 1.1 mm max height

PLASTIC SMALL OUTLINE



4222047/C 10/2022

### NOTES:

1. All linear dimensions are in millimeters. Any dimensions in parenthesis are for reference only. Dimensioning and tolerancing per ASME Y14.5M.
2. This drawing is subject to change without notice.
3. This dimension does not include mold flash, protrusions, or gate burrs. Mold flash, protrusions, or gate burrs shall not exceed 0.15 mm per side.

# EXAMPLE BOARD LAYOUT

DDF0008A

SOT-23 - 1.1 mm max height

PLASTIC SMALL OUTLINE



LAND PATTERN EXAMPLE  
SCALE:15X



NON SOLDER MASK  
DEFINED



SOLDER MASK  
DEFINED

## SOLDER MASK DETAILS

4222047/C 10/2022

NOTES: (continued)

4. Publication IPC-7351 may have alternate designs.
5. Solder mask tolerances between and around signal pads can vary based on board fabrication site.

# EXAMPLE STENCIL DESIGN

DDF0008A

SOT-23 - 1.1 mm max height

PLASTIC SMALL OUTLINE



SOLDER PASTE EXAMPLE  
BASED ON 0.125 mm THICK STENCIL  
SCALE:15X

4222047/C 10/2022

NOTES: (continued)

6. Laser cutting apertures with trapezoidal walls and rounded corners may offer better paste release. IPC-7525 may have alternate design recommendations.
7. Board assembly site may have different recommendations for stencil design.

## 重要声明和免责声明

TI“按原样”提供技术和可靠性数据（包括数据表）、设计资源（包括参考设计）、应用或其他设计建议、网络工具、安全信息和其他资源，不保证没有瑕疵且不做任何明示或暗示的担保，包括但不限于对适销性、某特定用途方面的适用性或不侵犯任何第三方知识产权的暗示担保。

这些资源可供使用 TI 产品进行设计的熟练开发人员使用。您将自行承担以下全部责任：(1) 针对您的应用选择合适的 TI 产品，(2) 设计、验证并测试您的应用，(3) 确保您的应用满足相应标准以及任何其他功能安全、信息安全、监管或其他要求。

这些资源如有变更，恕不另行通知。TI 授权您仅可将这些资源用于研发本资源所述的 TI 产品的应用。严禁对这些资源进行其他复制或展示。您无权使用任何其他 TI 知识产权或任何第三方知识产权。您应全额赔偿因在这些资源的使用中对 TI 及其代表造成的任何索赔、损害、成本、损失和债务，TI 对此概不负责。

TI 提供的产品受 [TI 的销售条款](#) 或 [ti.com](#) 上其他适用条款/TI 产品随附的其他适用条款的约束。TI 提供这些资源并不会扩展或以其他方式更改 TI 针对 TI 产品发布的适用的担保或担保免责声明。

TI 反对并拒绝您可能提出的任何其他或不同的条款。

邮寄地址：Texas Instruments, Post Office Box 655303, Dallas, Texas 75265

Copyright © 2023，德州仪器 (TI) 公司