

LM339B、LM2901B、LM339、LM239、LM139、LM2901 四路差分比较器

1 特性

- 新增了 [LM339B](#) 和 [LM2901B](#)
- 改进了 B 版本的规格
 - 最大额定值：高达 38V
 - ESD 等级 (HBM)：2kV
 - 低输入失调电压：0.37mV
 - 低输入偏置电流：3.5nA
 - 低电源电流：每个比较器 200 μ A
 - 更短的响应时间 (1 微秒)
 - [LM339B](#) 的工作温度范围
- B 版本可直接取代 [LM239](#)、[LM339](#) 和 [LM2901](#) 的 A 和 V 版本
- 共模输入电压范围包括接地
- 差分输入电压范围等于最大额定电源电压： $\pm 38V$
- 低输出饱和电压
- 输出与 TTL、MOS 和 CMOS 兼容
- 对于单通道版本，请参阅 [TL331B](#)
- 对于双通道版本，请参阅 [LM393B](#) 或 [LM2903B](#)

2 应用

- 扫地机器人
- 单相 UPS
- 服务器 PSU
- 无绳电动工具
- 无线基础设施
- 电器
- 楼宇自动化
- 工厂自动化与控制
- 电机驱动器
- 信息娱乐系统与仪表组

3 说明

[LM339B](#) 和 [LM2901B](#) 器件是业界通用 [LM339](#) 和 [LM2901](#) 比较器系列的下一代版本。下一代 B 版本比较器具有更低的失调电压、更高的电源电压能力、更低的电源电流、更低的输入偏置电流和更低的传播延迟，并通过专用 ESD 钳位提高了 2kV ESD 性能和输入耐用性。[LM339B](#) 和 [LM2901B](#) 可直接替代 [LM239](#)、[LM339](#) 和 [LM2901](#) (“A” 和 “V” 版本)。

所有器件都包含四个独立的电压比较器，这些比较器可在宽电压范围内由单电源供电运行。

器件信息

| 器件型号 | 封装 ⁽¹⁾ | 封装尺寸 (标称值) |
|---|-------------------|------------------|
| LM139x | CDIP (14) | 21.30mm × 7.60mm |
| LM139x、LM239x、 LM339x、LM2901x、 LM339B、LM2901B | SOIC (14) | 8.70mm × 3.90mm |
| LM239、LM339x、LM2901 | PDIP (14) | 19.30mm × 6.40mm |
| LM239、LM2901、 LM339B、LM2901B | TSSOP (14) | 5.00mm × 4.40mm |
| LM339x、LM2901、 LM339B、LM2901B | SO (14) | 10.20mm × 5.30mm |
| LM339x、LM339B | SSOP (14) | 6.50mm × 5.30mm |
| LM2901B | SOT-23 (14) | 4.20mm × 2.00mm |
| | WQFN (16) | 3.00mm × 3.00mm |

(1) 如需了解所有可用封装，请参阅数据表末尾的可订购产品附录。

系列比较表

| 规格 | LM339B | LM2901B | LM339 LM339A | LM2901 LM2901A | LM2901V LM2901AV | LM139 LM139A | LM239 LM239A | 单位 |
|-------------------------|------------------------|-------------------------|---|---|---|---|---|-----------|
| 电源电压 | 2 至 36 | 2 至 36 | 2 至 30 | 2 至 30 | 2 至 32 | 2 至 30 | 2 至 30 | V |
| 总电源电流 (5V 至 36V 最大值) | 0.8 至 1 | 0.8 至 1 | 1 至 2.5 | 1 至 2.5 | 1 至 2.5 | 1 至 2.5 | 1 至 2.5 | mA |
| 温度范围 | -40 至 85 | -40 至 125 | 0 至 70 | -40 至 125 | -40 至 125 | -55 至 125 | -25 至 85 | °C |
| ESD (HBM) | 2000 | 2000 | 1000 | 1000 | 1000 | 1000 | 1000 | V |
| 失调电压 (整个温度范围内的最大值) | ± 5.5 | ± 5.5 | ± 9 ± 4 | ± 15 ± 4 | ± 15 ± 4 | ± 9 ± 4 | ± 9 ± 4 | mV |
| 输入偏置电流 (典型值/最大值) | 3.5/25 | 3.5/25 | 25/250 | 25/250 | 25/250 | 25/100 | 25/250 | nA |
| 响应时间 (典型值) | 1 | 1 | 1.3 | 1.3 | 1.3 | 1.3 | 1.3 | μ sec |



Table of Contents

| | | | |
|--|----|--|----|
| 1 特性 | 1 | 7.16 Switching Characteristics for LMx39 and LMx39A.. | 14 |
| 2 应用 | 1 | 7.17 Switching Characteristics for LM2901..... | 14 |
| 3 说明 | 1 | 7.18 Typical Characteristics for LM339B and LM2901B Only..... | 15 |
| 4 Revision History | 3 | 7.19 Typical Characteristics, Non-B Versions..... | 21 |
| 5 Other Versions | 4 | 8 Detailed Description | 23 |
| 6 Pin Configuration and Functions | 5 | 8.1 Overview..... | 23 |
| 7 Specifications | 6 | 8.2 Functional Block Diagram..... | 23 |
| 7.1 Absolute Maximum Ratings for LM339B and LM2901B..... | 6 | 8.3 Feature Description..... | 23 |
| 7.2 Absolute Maximum Ratings for Non-B Versions..... | 6 | 8.4 Device Functional Modes..... | 23 |
| 7.3 ESD Ratings for LM339B and LM2901B..... | 7 | 9 Application and Implementation | 24 |
| 7.4 ESD Ratings, Non-B Versions..... | 7 | 9.1 Application Information..... | 24 |
| 7.5 Recommended Operating Conditions for LM339B and LM2901B..... | 7 | 9.2 Typical Application..... | 24 |
| 7.6 Recommended Operating Conditions, Non-B Versions..... | 7 | 10 Power Supply Recommendations | 26 |
| 7.7 Thermal Information for LM339B and LM2901B..... | 8 | 11 Layout | 27 |
| 7.8 Thermal Information for Non-B Versions..... | 8 | 11.1 Layout Guidelines..... | 27 |
| 7.9 Electrical Characteristics for LM339B..... | 9 | 11.2 Layout Example..... | 27 |
| 7.10 Electrical Characteristics for LM2901B..... | 9 | 12 Device and Documentation Support | 28 |
| 7.11 Electrical Characteristics for LM139 and LM139A.. | 11 | 12.1 Related Links..... | 28 |
| 7.12 Electrical Characteristics for LMx39 and LMx39A.. | 12 | 12.2 Receiving Notification of Documentation Updates.. | 28 |
| 7.13 Electrical Characteristics for LM2901, LM2901V and LM2901AV..... | 13 | 12.3 支持资源..... | 28 |
| 7.14 Switching Characteristics for LM139 and LM139A..... | 14 | 12.4 Trademarks..... | 28 |
| 7.15 Switching Characteristics for LM339B and LM2901B..... | 14 | 12.5 Electrostatic Discharge Caution..... | 28 |
| | | 12.6 术语表..... | 28 |
| | | 13 Mechanical, Packaging, and Orderable Information | 29 |

4 Revision History

注：以前版本的页码可能与当前版本的页码不同

| Changes from Revision U (November 2018) to Revision V (December 2022) | Page |
|---|-------------|
| • 更新了整个文档中的表格、图和交叉参考的编号格式。..... | 1 |
| • 通篇添加了“B”版本。添加了“器件系列”表..... | 1 |
| <hr/> | |
| Changes from Revision T (June 2015) to Revision U (November 2018) | Page |
| • 在 <i>描述</i> 部分中将 LM239x 温度范围从 125°C 更改为 85°C..... | 1 |
| • 更改了数据表标题..... | 1 |
| • Changed LM293AD to LM239AD in <i>Device Comparison Table</i> | 4 |
| • Added Input Current and related footnote in <i>Absolute Maximum Ratings</i> | 6 |
| • Changed layout of <i>Recommended Operating Conditions</i> temperatures to separate rows..... | 7 |
| • Changed values in the Thermal Information table to align with JEDEC standards..... | 8 |
| • Added LM2901V and LMV2901AV to LM2901 Elect Char Table title to make more clear which devices are covered..... | 13 |
| • Changed "Dual" to "Quad" and removed "Absolute Maximum" wording and mention of Q100 in <i>Overview</i> section text..... | 23 |
| • Changed and corrected text in <i>Feature Description</i> section..... | 23 |
| • Changed Example Values in <i>Typical Application Design Parameters</i> table | 24 |
| • Added <i>Receiving Notification of Documentation Updates</i> section..... | 28 |
| <hr/> | |
| Changes from Revision S (August 2012) to Revision T (June 2015) | Page |
| • 删除了 <i>订购信息表</i> | 1 |
| • 向 <i>特性</i> 列表中添加了“军用免责声明”。..... | 1 |
| • 添加了 <i>应用</i> 、 <i>器件信息表</i> 、 <i>引脚配置和功能</i> 部分、 <i>ESD</i> 等级表、 <i>热性能信息表</i> 、 <i>特性说明</i> 部分、 <i>器件功能模式</i> 、 <i>应用和实施</i> 部分、 <i>电源相关建议</i> 部分、 <i>布局</i> 部分、 <i>器件和文档支持</i> 部分以及 <i>机械、封装和可订购信息</i> 部分。无规格变化..... | 1 |

5 Other Versions

OTHER QUALIFIED VERSIONS OF LM139-SP, LM239A, LM2901, LM2901AV, LM2901V:

- Automotive Q100: [LM239A-Q1](#), [LM2901B-Q1](#), [LM2901-Q1](#), [LM2901AV-Q1](#), [LM2901V-Q1](#)
- Enhanced Product: [LM239A-EP](#)
- Space: [LM139-SP](#)

6 Pin Configuration and Functions

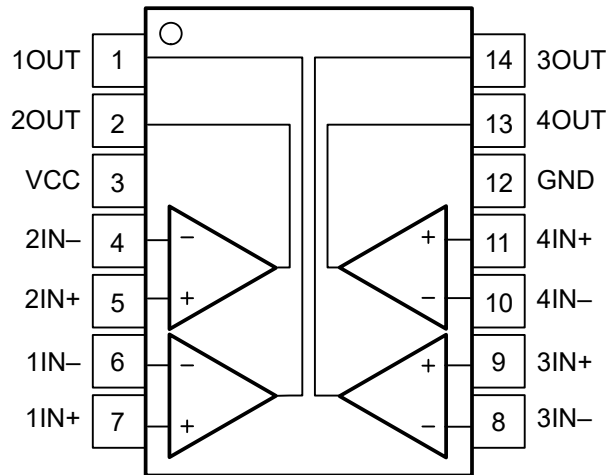

**图 6-1. D, DB, N, NS, PW, DYY, J Packages
14-Pin SOIC, SSOP, PDIP, SO, TSSOP, SOT-23,
CDIP
Top View**

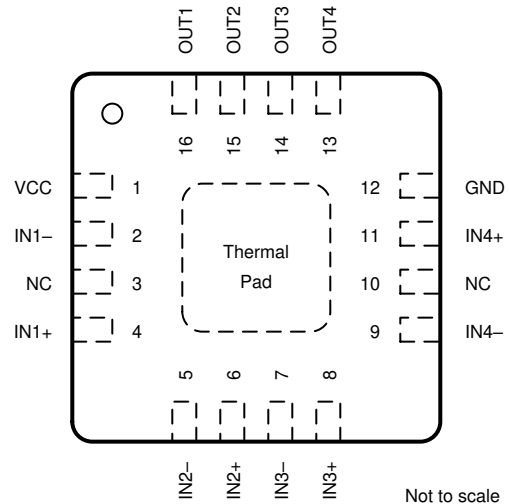

NOTE: Connect exposed thermal pad directly to GND pin.

**图 6-2. RTE Package
16-Pad WQFN With Exposed Thermal Pad
Top View**

表 6-1. Pin Functions

| NAME ⁽¹⁾ | PIN | | I/O | DESCRIPTION |
|----------------------|--------------------------|------|--------|--|
| | D, DB, N, NS, PW, DYY, J | WQFN | | |
| OUT1 ⁽¹⁾ | 1 | 16 | Output | Output pin of the comparator 2 |
| OUT2 ⁽¹⁾ | 2 | 15 | Output | Output pin of the comparator 1 |
| V _{CC} | 3 | 1 | — | Positive supply |
| IN2 ⁻ (1) | 4 | 5 | Input | Negative input pin of the comparator 1 |
| IN2 ⁺ (1) | 5 | 6 | Input | Positive input pin of the comparator 1 |
| IN1 ⁻ (1) | 6 | 2 | Input | Negative input pin of the comparator 2 |
| IN1 ⁺ (1) | 7 | 4 | Input | Positive input pin of the comparator 2 |
| IN3 ⁻ | 8 | 7 | Input | Negative input pin of the comparator 3 |
| IN3 ⁺ | 9 | 8 | Input | Positive input pin of the comparator 3 |
| IN4 ⁻ | 10 | 9 | Input | Negative input pin of the comparator 4 |
| IN4 ⁺ | 11 | 11 | Input | Positive input pin of the comparator 4 |
| GND | 12 | 12 | — | Negative supply |
| OUT4 | 13 | 13 | Output | Output pin of the comparator 4 |
| OUT3 | 14 | 14 | Output | Output pin of the comparator 3 |
| NC | — | 3 | — | No Internal Connection - Leave floating or GND |
| NC | — | 10 | — | No Internal Connection - Leave floating or GND |
| Thermal Pad | — | PAD | — | Connect directly to GND pin |

(1) Some manufacturers transpose the names of channels 1 & 2. Electrically the pinouts are identical, just a difference in the channel naming convention.

7 Specifications

7.1 Absolute Maximum Ratings for LM339B and LM2901B

over operating free-air temperature range (unless otherwise noted)⁽¹⁾

| | MIN | MAX | UNIT |
|---|------|-----------|------|
| Supply voltage: $V_S = (V+) - (V-)$ | -0.3 | 38 | V |
| Differential input voltage: V_{ID} ⁽²⁾ | | ±38 | V |
| Input pins (IN+, IN -) | -0.3 | 38 | V |
| Current into input pins (IN+, IN -) | | -50 | mA |
| Output pin (OUT) | -0.3 | 38 | V |
| Output sink current | | 25 | mA |
| Output short-circuit duration ⁽³⁾ | | Unlimited | s |
| Junction temperature, T_J | TBD | 150 | °C |
| Storage temperature, T_{stg} | -65 | 150 | °C |

- (1) Stresses beyond those listed under *Absolute Maximum Ratings* may cause permanent damage to the device. These are stress ratings only, which do not imply functional operation of the device at these or any other conditions beyond those indicated under *Recommended Operating Conditions*. Exposure to absolute-maximum-rated conditions for extended periods may affect device reliability.
- (2) Differential voltages are at IN+ with respect to IN-
- (3) Short circuits from outputs to V+ can cause excessive heating and eventual destruction.

7.2 Absolute Maximum Ratings for Non-B Versions

over operating free-air temperature range (unless otherwise noted)⁽¹⁾

| | MIN | MAX | UNIT |
|---|-------|------------|--------|
| V_{CC} Supply voltage ⁽²⁾ | | 36 | V |
| V_{ID} Differential input voltage ⁽³⁾ | | ±36 | V |
| V_I Input voltage range (either input) | - 0.3 | 36 | V |
| I_K Input current ⁽⁵⁾ | | - 50 | mA |
| V_O Output voltage | | 36 | V |
| I_O Output current | | 20 | mA |
| Duration of output short circuit to ground ⁽⁴⁾ | | Unlimited | |
| T_J Operating virtual-junction temperature | | 150 | °C |
| Case temperature for 60 s | | FK package | 260 °C |
| Lead temperature 1.6 mm (1/16 in) from case for 60 s | | J package | 300 °C |
| T_{stg} Storage temperature | - 65 | 150 | °C |

- (1) Stresses beyond those listed under *Absolute Maximum Ratings* may cause permanent damage to the device. These are stress ratings only, and functional operation of the device at these or any other conditions beyond those indicated under *Recommended Operating Conditions* is not implied. Exposure to absolute-maximum-rated conditions for extended periods may affect device reliability.
- (2) All voltage values, except differential voltages, are with respect to network ground.
- (3) Differential voltages are at xIN+ with respect to xIN - .
- (4) Short circuits from outputs to V_{CC} can cause excessive heating and eventual destruction.
- (5) Input current flows through parasitic diode to ground and will turn on parasitic transistors that will increase I_{CC} and may cause output to be incorrect. Normal operation resumes when input is removed.

7.3 ESD Ratings for LM339B and LM2901B

| | | | VALUE | UNIT |
|--------------------|-------------------------|---|-------|------|
| V _(ESD) | Electrostatic discharge | Human-body model (HBM), per ANSI/ESDA/JEDEC JS-001 ⁽¹⁾ | ±2000 | V |
| | | Human-body model (HBM), per ANSI/ESDA/JEDEC JS-002 ⁽²⁾ | ±1000 | |

- (1) JEDEC document JEP155 states that 500-V HBM allows safe manufacturing with a standard ESD control process
(2) JEDEC document JEP157 states that 250-V CDM allows safe manufacturing with a standard ESD control process

7.4 ESD Ratings, Non-B Versions

| | | | VALUE | UNIT |
|--------------------|-------------------------|--|-------|------|
| V _(ESD) | Electrostatic discharge | Human body model (HBM), per ANSI/ESDA/JEDEC JS-001 ⁽¹⁾ | ±500 | V |
| | | Charged-device model (CDM), per JEDEC specification JESD22-C101 ⁽²⁾ | ±750 | |

- (1) JEDEC document JEP155 states that 500-V HBM allows safe manufacturing with a standard ESD control process.
(2) JEDEC document JEP157 states that 250-V CDM allows safe manufacturing with a standard ESD control process.

7.5 Recommended Operating Conditions for LM339B and LM2901B

over operating free-air temperature range (unless otherwise noted)

| | MIN | MAX | UNIT |
|--------------------------------------|--------------|--------------|------|
| Supply voltage: $V_S = (V+) - (V-)$ | 2 | 36 | V |
| Ambient temperature, T_A , LM339B | - 40 | 85 | °C |
| Ambient temperature, T_A , LM2901B | - 40 | 125 | °C |
| Input Voltage Range, V_{IVR} | $(V-) - 0.1$ | $(V+) - 2.0$ | V |

7.6 Recommended Operating Conditions, Non-B Versions

over operating free-air temperature range (unless otherwise noted)

| | | | MIN | MAX | UNIT |
|-----------------|----------------------|---------------|------|-----|------|
| V _{CC} | Supply voltage | Non-V devices | 2 | 30 | V |
| | | V devices | 2 | 32 | V |
| T _J | Junction temperature | LM139x | - 55 | 125 | °C |
| | | LM239x | - 25 | 85 | |
| | | LM339x | - 0 | 70 | |
| | | LM2901x | - 40 | 125 | |

7.7 Thermal Information for LM339B and LM2901B

| THERMAL METRIC ⁽¹⁾ | | LM339B, LM2901B | | | | | UNIT |
|-------------------------------|--|-----------------|------------|--------------|-----------|-----------|------|
| | | D (SOIC) | PW (TSSOP) | DDY (SOT-23) | RUC (QFN) | RTE (QFN) | |
| | | 14 PINS | 14 PINS | 14 PINS | 14 PINS | 16 PINS | |
| $R_{\theta JA}$ | Junction-to-ambient thermal resistance | 111.2 | 136.6 | | | | °C/W |
| $R_{\theta JC(top)}$ | Junction-to-case (top) thermal resistance | 66.9 | 66.6 | | | | °C/W |
| $R_{\theta JB}$ | Junction-to-board thermal resistance | 67.8 | 79.8 | | | | °C/W |
| ψ_{JT} | Junction-to-top characterization parameter | 28.0 | 17.8 | | | | °C/W |
| ψ_{JB} | Junction-to-board characterization parameter | 67.4 | 79.3 | | | | °C/W |
| $R_{\theta JC(bot)}$ | Junction-to-case (bottom) thermal resistance | - | - | - | | | °C/W |

(1) For more information about traditional and new thermal metrics, see the Semiconductor and IC Package Thermal Metrics report, [SPRA953](#).

7.8 Thermal Information for Non-B Versions

| THERMAL METRIC ⁽¹⁾ | | LMx39, LM2901x | | | | | | | UNIT |
|-------------------------------|--|----------------|-----------|----------|---------|------------|----------|---------|------|
| | | D (SOIC) | DB (SSOP) | N (PDIP) | NS (SO) | PW (TSSOP) | J (CDIP) | W (CFP) | |
| $R_{\theta JA}$ | Junction-to-ambient thermal resistance | 98.8 | 111.8 | 79 | 96.2 | 120 | 89.5 | 156.2 | °C/W |
| $R_{\theta JC(top)}$ | Junction-to-case (top) thermal resistance | 64.3 | 63.6 | 73.4 | 56.1 | 59 | 46.1 | 86.7 | °C/W |
| $R_{\theta JB}$ | Junction-to-board thermal resistance | 59.7 | 60.5 | 58.7 | 56.9 | 68.8 | 78.7 | 154.6 | °C/W |
| ψ_{JT} | Junction-to-top characterization parameter | 25.7 | 26.2 | 48.3 | 24.8 | 9.9 | 3 | 56.5 | °C/W |
| ψ_{JB} | Junction-to-board characterization parameter | 59.3 | 59.8 | 58.5 | 56.4 | 68.2 | 71.8 | 133.5 | °C/W |
| $R_{\theta JC(bot)}$ | Junction-to-case (bottom) thermal resistance | — | — | — | — | — | 24.2 | 14.3 | °C/W |

(1) For more information about traditional and new thermal metrics, see the [Semiconductor and IC Package Thermal Metrics](#) application report.

7.9 Electrical Characteristics for LM339B

$V_S = 5\text{ V}$, $V_{CM} = (V^-)$; $T_A = 25^\circ\text{C}$ (unless otherwise noted).

| PARAMETER | | TEST CONDITIONS | MIN | TYP | MAX | UNIT |
|--------------|--|--|---------|------------|---------------|------|
| V_{IO} | Input offset voltage | $V_S = 5\text{ to }36\text{V}$ | - 3.5 | ± 0.37 | 3.5 | mV |
| | | $V_S = 5\text{ to }36\text{V}$, $T_A = -40^\circ\text{C to }+85^\circ\text{C}$ | - 5.5 | | 5.5 | |
| I_B | Input bias current | | | - 3 | - 25 | nA |
| | | $T_A = -40^\circ\text{C to }+85^\circ\text{C}$ | | | - 50 | nA |
| I_{OS} | Input offset current | | - 25 | ± 0.5 | 25 | nA |
| | | $T_A = -40^\circ\text{C to }+85^\circ\text{C}$ | - 50 | | 50 | nA |
| V_{CM} | Common mode range ⁽¹⁾ | $V_S = 3\text{ to }36\text{V}$ | (V^-) | | $(V^+) - 1.5$ | V |
| | | $V_S = 3\text{ to }36\text{V}$, $T_A = -40^\circ\text{C to }+85^\circ\text{C}$ | (V^-) | | $(V^+) - 2.0$ | V |
| A_{VD} | Large signal differential voltage amplification ⁽²⁾ | $V_S = 15\text{V}$, $V_O = 1.4\text{V to }11.4\text{V}$; $R_L \geq 15\text{k to } (V^+)$ | 50 | 200 | | V/mV |
| V_{OL} | Low level output Voltage {swing from (V^-) } | $I_{SINK} \leq 4\text{mA}$, $V_{ID} = -1\text{V}$ | | 110 | 400 | mV |
| | | $I_{SINK} \leq 4\text{mA}$, $V_{ID} = -1\text{V}$ $T_A = -40^\circ\text{C to }+85^\circ\text{C}$ | | | 550 | mV |
| I_{OH-LKG} | High-level output leakage current | $(V^+) = V_O = 5\text{ V}$; $V_{ID} = 1\text{V}$ | | 0.1 | 50 | nA |
| | | $(V^+) = V_O = 36\text{V}$; $V_{ID} = 1\text{V}$ | | | 100 | nA |
| I_{OL} | Low level output current | $V_{OL} = 1.5\text{V}$; $V_{ID} = -1\text{V}$; $V_S = 5\text{V}$ | 6 | 21 | | mA |
| I_Q | Quiescent current (all comparators) | $V_S = 5\text{ V}$, no load | | 0.8 | 1.2 | mA |
| | | $V_S = 36\text{ V}$, no load, $T_A = -40^\circ\text{C to }+85^\circ\text{C}$ | | 1 | 1.6 | mA |

- (1) The voltage at either input should not be allowed to go negative by more than 0.3 V otherwise output may be incorrect and excessive input current can flow. The upper end of the common-mode voltage range is limited by $V_{CC} - 2\text{V}$. However only one input needs to be in the valid common mode range, the other input can go up the maximum V_{CC} level and the comparator provides a proper output state. Either or both inputs can go to maximum V_{CC} level without damage.
- (2) This parameter is ensured by design and/or characterization and is not tested in production.

7.10 Electrical Characteristics for LM2901B

$V_S = 5\text{ V}$, $V_{CM} = (V^-)$; $T_A = 25^\circ\text{C}$ (unless otherwise noted).

| PARAMETER | | TEST CONDITIONS | MIN | TYP | MAX | UNIT |
|--------------|--|---|---------|------------|---------------|------|
| V_{IO} | Input offset voltage | $V_S = 5\text{ to }36\text{V}$ | - 3.5 | ± 0.37 | 3.5 | mV |
| | | $V_S = 5\text{ to }36\text{V}$, $T_A = -40^\circ\text{C to }+125^\circ\text{C}$ | - 5.5 | | 5.5 | |
| I_B | Input bias current | | | - 3 | - 25 | nA |
| | | $T_A = -40^\circ\text{C to }+125^\circ\text{C}$ | | | - 50 | nA |
| I_{OS} | Input offset current | | - 25 | ± 0.5 | 25 | nA |
| | | $T_A = -40^\circ\text{C to }+125^\circ\text{C}$ | - 50 | | 50 | nA |
| V_{CM} | Common mode range ⁽¹⁾ | $V_S = 3\text{ to }36\text{V}$ | (V^-) | | $(V^+) - 1.5$ | V |
| | | $V_S = 3\text{ to }36\text{V}$, $T_A = -40^\circ\text{C to }+125^\circ\text{C}$ | (V^-) | | $(V^+) - 2.0$ | V |
| A_{VD} | Large signal differential voltage amplification ⁽²⁾ | $V_S = 15\text{V}$, $V_O = 1.4\text{V to }11.4\text{V}$; $R_L \geq 15\text{k to } (V^+)$ | 50 | 200 | | V/mV |
| V_{OL} | Low level output Voltage {swing from (V^-) } | $I_{SINK} \leq 4\text{mA}$, $V_{ID} = -1\text{V}$ | | 110 | 400 | mV |
| | | $I_{SINK} \leq 4\text{mA}$, $V_{ID} = -1\text{V}$ $T_A = -40^\circ\text{C to }+125^\circ\text{C}$ | | | 550 | mV |
| I_{OH-LKG} | High-level output leakage current | $(V^+) = V_O = 5\text{ V}$; $V_{ID} = 1\text{V}$ | | 0.1 | 50 | nA |
| | | $(V^+) = V_O = 36\text{V}$; $V_{ID} = 1\text{V}$ | | | 100 | nA |
| I_{OL} | Low level output current | $V_{OL} = 1.5\text{V}$; $V_{ID} = -1\text{V}$; $V_S = 5\text{V}$ | 6 | 21 | | mA |
| I_Q | Quiescent current (all comparators) | $V_S = 5\text{ V}$, no load | | 0.8 | 1.2 | mA |
| | | $V_S = 36\text{ V}$, no load, $T_A = -40^\circ\text{C to }+125^\circ\text{C}$ | | 1 | 1.6 | mA |

- (1) The voltage at either input should not be allowed to go negative by more than 0.3 V otherwise output may be incorrect and excessive input current can flow. The upper end of the common-mode voltage range is limited by $V_{CC} - 2\text{V}$. However only one input needs to be in the valid common mode range, the other input can go up the maximum V_{CC} level and the comparator provides a proper output state. Either or both inputs can go to maximum V_{CC} level without damage.

(2) This parameter is ensured by design and/or characterization and is not tested in production.

7.11 Electrical Characteristics for LM139 and LM139A

at specified free-air temperature, $V_{CC} = 5\text{ V}$ (unless otherwise noted)

| PARAMETER | TEST CONDITIONS ⁽¹⁾ | T_A ⁽²⁾ | LM139 | | LM139A | | UNIT | |
|--|---|------------------------|------------------------|-----|--------|------------------------|------|----------------|
| | | | MIN | TYP | MAX | MIN | | TYP |
| V_{IO} Input offset voltage | $V_{CC} = 5\text{ V to }30\text{ V}$, $V_{IC} = V_{ICR}\text{ min}$, $V_O = 1.4\text{ V}$ | 25°C | | 2 | 5 | 1 | 2 | mV |
| | | Full range | | | 9 | | 4 | |
| I_{IO} Input offset current | $V_O = 1.4\text{ V}$ | 25°C | | 3 | 25 | 3 | 25 | nA |
| | | Full range | | | 100 | | 100 | |
| I_{IB} Input bias current | $V_O = 1.4\text{ V}$ | 25°C | | -25 | - | -25 | -100 | nA |
| | | Full range | | | 300 | | -300 | |
| V_{ICR} Common-mode input-voltage range ⁽³⁾ | | 25°C | 0 to $V_{CC} - 1.5$ | | | 0 to $V_{CC} - 1.5$ | | V |
| | | Full range | 0 to $V_{CC} - 2$ | | | 0 to $V_{CC} - 2$ | | |
| A_{VD} Large-signal differential-voltage amplification | $V_{CC+} = \pm 7.5\text{ V}$, $V_O = -5\text{ V to }5\text{ V}$ | 25°C | | 200 | | 50 | 200 | V/mV |
| I_{OH} High-level output current | $V_{ID} = 1\text{ V}$ | $V_{OH} = 5\text{ V}$ | 25°C | | 0.1 | | 0.1 | nA |
| | | $V_{OH} = 30\text{ V}$ | Full range | | | | 1 | $\mu\text{ A}$ |
| V_{OL} Low-level output voltage | $V_{ID} = -1\text{ V}$, $I_{OL} = 4\text{ mA}$ | 25°C | | 150 | 400 | 150 | 400 | mV |
| | | Full range | | | 700 | | 700 | |
| I_{OL} Low-level output current | $V_{ID} = -1\text{ V}$, $V_{OL} = 1.5\text{ V}$ | 25°C | | 6 | 16 | 6 | 16 | mA |
| I_{CC} Supply current (four comparators) | $V_O = 2.5\text{ V}$, No load | 25°C | | 0.8 | 2 | 0.8 | 2 | mA |

- (1) All characteristics are measured with zero common-mode input voltage, unless otherwise specified.
- (2) Full range (MIN to MAX) for LM139 and LM139A is -55°C to $+125^\circ\text{C}$. All characteristics are measured with zero common-mode input voltage, unless otherwise specified.
- (3) The voltage at either input or common-mode must not be allowed to go negative by more than 0.3 V. The upper end of the common-mode voltage range is $V_{CC+} - 1.5\text{ V}$; however, one input can exceed V_{CC} , and the comparator will provide a proper output state as long as the other input remains in the common-mode range. Either or both inputs can go to 30 V without damage.

7.12 Electrical Characteristics for LMx39 and LMx39A

at specified free-air temperature, $V_{CC} = 5\text{ V}$ (unless otherwise noted)

| PARAMETER | TEST CONDITIONS ⁽¹⁾ | T_A ⁽²⁾ | LM239 LM339 | | | LM239A LM339A | | | UNIT | |
|--|--|------------------------|----------------|------------------------|-----|------------------|------------------------|-------|------|----------------|
| | | | MIN | TYP | MAX | MIN | TYP | MAX | | |
| V_{IO} Input offset voltage | $V_{CC} = 5\text{ V to }30\text{ V}$, $V_{IC} = V_{ICR\text{ min}}$, $V_O = 1.4\text{ V}$ | 25°C | | 2 | 5 | | 1 | 3 | mV | |
| | | Full range | | | 9 | | | 4 | | |
| I_{IO} Input offset current | $V_O = 1.4\text{ V}$ | 25°C | | 5 | 50 | | 5 | 50 | nA | |
| | | Full range | | | 150 | | | 150 | | |
| I_{IB} Input bias current | $V_O = 1.4\text{ V}$ | 25°C | | - 25 | - | | - 25 | - 250 | nA | |
| | | Full range | | | 400 | | | - 400 | | |
| V_{ICR} Common-mode input-voltage range ⁽³⁾ | | 25°C | | 0 to $V_{CC} - 1.5$ | | | 0 to $V_{CC} - 1.5$ | | V | |
| | | Full range | | 0 to $V_{CC} - 2$ | | | 0 to $V_{CC} - 2$ | | | |
| A_{VD} Large-signal differential-voltage amplification | $V_{CC} = 15\text{ V}$, $V_O = 1.4\text{ V to }11.4\text{ V}$, $R_L \geq 15\text{ k}\Omega\text{ to }V_{CC}$ | 25°C | | 50 | 200 | | 50 | 200 | V/mV | |
| I_{OH} High-level output current | $V_{ID} = 1\text{ V}$ | $V_{OH} = 5\text{ V}$ | 25°C | | 0.1 | 50 | | 0.1 | 50 | nA |
| | | $V_{OH} = 30\text{ V}$ | Full range | | | 1 | | | 1 | $\mu\text{ A}$ |
| V_{OL} Low-level output voltage | $V_{ID} = -1\text{ V}$, $I_{OL} = 4\text{ mA}$ | 25°C | | 150 | 400 | | 150 | 400 | mV | |
| | | Full range | | | 700 | | | 700 | | |
| I_{OL} Low-level output current | $V_{ID} = -1\text{ V}$, $V_{OL} = 1.5\text{ V}$ | 25°C | | 6 | 16 | | 6 | 16 | mA | |
| I_{CC} Supply current (four comparators) | $V_O = 2.5\text{ V}$, No load | 25°C | | 0.8 | 2 | | 0.8 | 2 | mA | |

- (1) All characteristics are measured with zero common-mode input voltage, unless otherwise specified.
- (2) Full range (MIN to MAX) for LM239/LM239A is -25°C to $+85^\circ\text{C}$, and for LM339/LM339A is 0°C to 70°C . All characteristics are measured with zero common-mode input voltage, unless otherwise specified.
- (3) The voltage at either input or common-mode must not be allowed to go negative by more than 0.3 V. The upper end of the common-mode voltage range is $V_{CC+} - 1.5\text{ V}$; however, one input can exceed V_{CC} , and the comparator will provide a proper output state as long as the other input remains in the common-mode range. Either or both inputs can go to 30 V without damage.

7.13 Electrical Characteristics for LM2901, LM2901V and LM2901AV

at specified free-air temperature, $V_{CC} = 5\text{ V}$ (unless otherwise noted)

| PARAMETER | TEST CONDITIONS ⁽¹⁾ | | T_A ⁽²⁾ | LM2901 | | | UNIT |
|--|---|------------------------------------|----------------------|---------------------|------|----------------|------|
| | | | | MIN | TYP | MAX | |
| V_{IO} Input offset voltage | $V_{IC} = V_{ICR\text{ min}}$, $V_O = 1.4\text{ V}$, $V_{CC} = 5\text{ V to MAX}^{(3)}$ | Non-A devices | 25°C | 2 | 7 | mV | |
| | | | Full range | | 15 | | |
| | | A-suffix devices | 25°C | 1 | 2 | | |
| | | | Full range | | 4 | | |
| I_{IO} Input offset current | $V_O = 1.4\text{ V}$ | | 25°C | 5 | 50 | nA | |
| | | | Full range | | 200 | | |
| I_{IB} Input bias current | $V_O = 1.4\text{ V}$ | | 25°C | -25 | -250 | nA | |
| | | | Full range | | -500 | | |
| V_{ICR} Common-mode input-voltage range ⁽⁴⁾ | | | 25°C | 0 to $V_{CC} - 1.5$ | | V | |
| | | | Full range | 0 to $V_{CC} - 2$ | | | |
| A_{VD} Large-signal differential-voltage amplification | $V_{CC} = 15\text{ V}$, $V_O = 1.4\text{ V to } 11.4\text{ V}$, $R_L \geq 15\text{ k}\Omega\text{ to } V_{CC}$ | | 25°C | 25 | 100 | V/mV | |
| I_{OH} High-level output current | $V_{ID} = 1\text{ V}$ | $V_{OH} = 5\text{ V}$ | 25°C | 0.1 | 50 | nA | |
| | | $V_{OH} = V_{CC}\text{ MAX}^{(3)}$ | Full range | | 1 | $\mu\text{ A}$ | |
| V_{OL} Low-level output voltage | $V_{ID} = -1\text{ V}$, $I_{OL} = 4\text{ mA}$ | Non-V devices | 25°C | 150 | 500 | mV | |
| | | V-suffix devices | | 150 | 400 | | |
| | | All devices | Full range | | 700 | | |
| I_{OL} Low-level output current | $V_{ID} = -1\text{ V}$, | $V_{OL} = 1.5\text{ V}$ | 25°C | 6 | 16 | mA | |
| I_{CC} Supply current (four comparators) | $V_O = 2.5\text{ V}$, No load | $V_{CC} = 5\text{ V}$ | 25°C | 0.8 | 2 | mA | |
| | | $V_{CC} = \text{MAX}^{(3)}$ | | 1 | 2.5 | | |

- (1) All characteristics are measured with zero common-mode input voltage, unless otherwise specified.
- (2) Full range (MIN to MAX) for LM2901 is -40°C to $+125^\circ\text{C}$. All characteristics are measured with zero common-mode input voltage, unless otherwise specified.
- (3) $V_{CC}\text{ MAX} = 30\text{ V}$ for non-V devices, and 32 V for V-suffix devices
- (4) The voltage at either input or common-mode must not be allowed to go negative by more than 0.3 V . The upper end of the common-mode voltage range is $V_{CC+} - 1.5\text{ V}$; however, one input can exceed V_{CC} , and the comparator will provide a proper output state as long as the other input remains in the common-mode range. Either or both inputs can go to $V_{CC}\text{ MAX}$ without damage.

7.14 Switching Characteristics for LM139 and LM139A

$V_{CC} = 5\text{ V}$, $T_A = 25^\circ\text{C}$

| PARAMETER | TEST CONDITIONS | | LM139 LM139A | UNIT |
|---------------|---|---------------------------------------|-----------------|----------------|
| | | | TYP | |
| Response time | R_L connected to 5 V through 5.1 k Ω , $C_L = 15\text{ pF}^{(1)}\text{ }^{(2)}$ | 100-mV input step with 5-mV overdrive | 1.3 | $\mu\text{ s}$ |
| | | TTL-level input step | 0.3 | |

(1) C_L includes probe and jig capacitance.

(2) The response time specified is the interval between the input step function and the instant when the output crosses 1.4 V.

7.15 Switching Characteristics for LM339B and LM2901B

$V_S = 5\text{ V}$, $V_{O_PULLUP} = 5\text{ V}$, $V_{CM} = V_S/2$, $C_L = 15\text{ pF}$, $R_L = 5.1\text{ k}\Omega$, $T_A = 25^\circ\text{C}$ (unless otherwise noted).

| PARAMETER | | TEST CONDITIONS | MIN | TYP | MAX | UNIT |
|-----------------------|---|--|-----|------|-----|------|
| t_{response} | Propagation delay time, high-to-low; Small scale input signal ⁽¹⁾ | Input overdrive = 5mV, Input step = 100mV | | 1000 | | ns |
| t_{response} | Propagation delay time, high-to-low; TTL input signal ⁽¹⁾ | TTL input with $V_{\text{ref}} = 1.4\text{ V}$ | | 300 | | ns |

(1) High-to-low and low-to-high refers to the transition at the input.

7.16 Switching Characteristics for LMx39 and LMx39A

$V_{CC} = 5\text{ V}$, $T_A = 25^\circ\text{C}$

| PARAMETER | TEST CONDITIONS | | LM239 LM239A LM339 LM339A | UNIT |
|---------------|---|---------------------------------------|------------------------------------|----------------|
| | | | TYP | |
| Response time | R_L connected to 5 V through 5.1 k Ω , $C_L = 15\text{ pF}^{(1)}\text{ }^{(2)}$ | 100-mV input step with 5-mV overdrive | 1.3 | $\mu\text{ s}$ |
| | | TTL-level input step | 0.3 | |

(1) C_L includes probe and jig capacitance.

(2) The response time specified is the interval between the input step function and the instant when the output crosses 1.4 V.

7.17 Switching Characteristics for LM2901

$V_{CC} = 5\text{ V}$, $T_A = 25^\circ\text{C}$

| PARAMETER | TEST CONDITIONS | | LM2901 | UNIT |
|---------------|---|---------------------------------------|--------|----------------|
| | | | TYP | |
| Response time | R_L connected to 5 V through 5.1 k Ω , $C_L = 15\text{ pF}^{(1)}\text{ }^{(2)}$ | 100-mV input step with 5-mV overdrive | 1.3 | $\mu\text{ s}$ |
| | | TTL-level input step | 0.3 | |

(1) C_L includes probe and jig capacitance.

(2) The response time specified is the interval between the input step function and the instant when the output crosses 1.4 V.

7.18 Typical Characteristics for LM339B and LM2901B Only

$T_A = 25^\circ\text{C}$, $V_S = 5\text{ V}$, $R_{\text{PULLUP}} = 5.1\text{ k}$, $C_L = 15\text{ pF}$, $V_{\text{CM}} = 0\text{ V}$, $V_{\text{UNDERDRIVE}} = 100\text{ mV}$, $V_{\text{OVERDRIVE}} = 100\text{ mV}$ unless otherwise noted.



图 7-1. Total Supply Current vs. Supply Voltage



图 7-2. Total Supply Current vs. Input Voltage at 3V

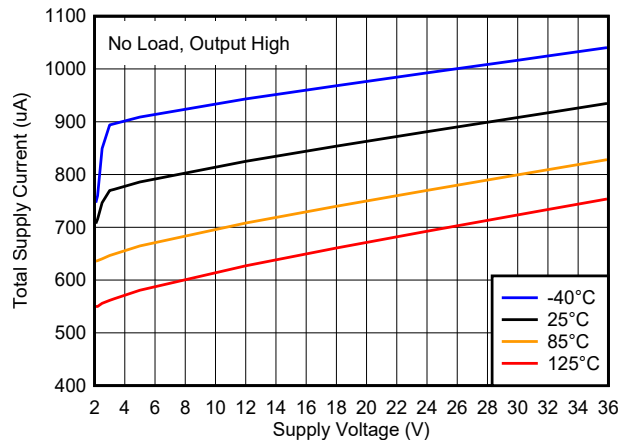

图 7-3. Total Supply Current vs. Input Voltage at 3.3V

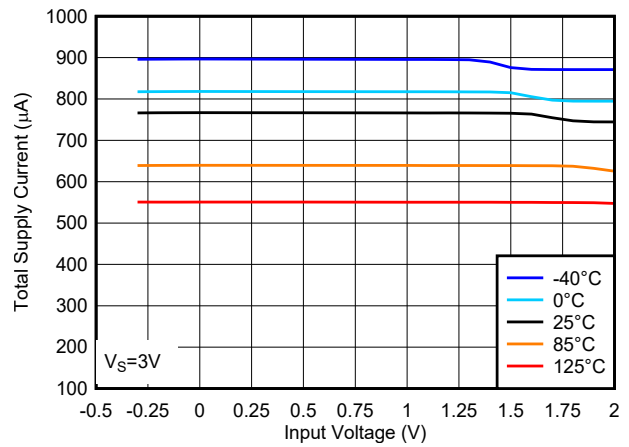

图 7-4. Total Supply Current vs. Input Voltage at 5V

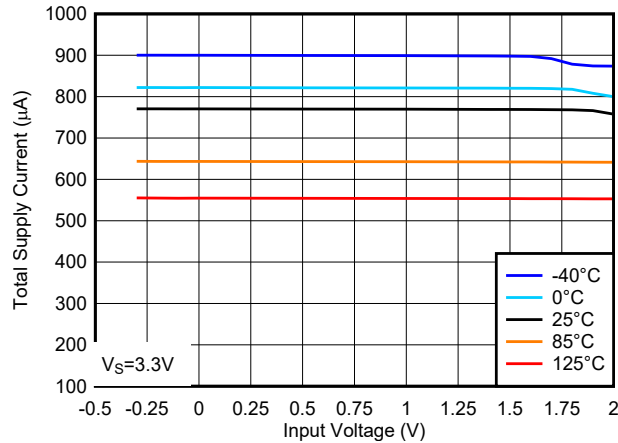

图 7-5. Total Supply Current vs. Input Voltage at 12V

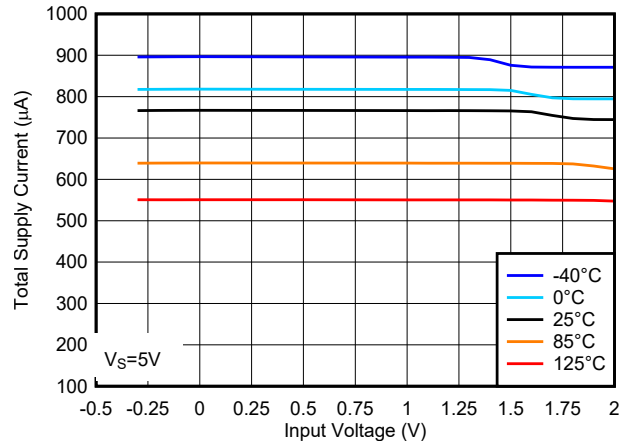

图 7-6. Total Supply Current vs. Input Voltage at 36V

7.18 Typical Characteristics for LM339B and LM2901B Only (continued)

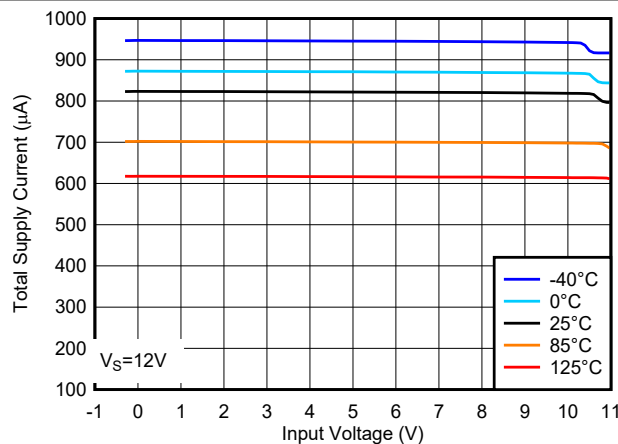
$T_A = 25^\circ\text{C}$, $V_S = 5\text{ V}$, $R_{\text{PULLUP}} = 5.1\text{ k}$, $C_L = 15\text{ pF}$, $V_{\text{CM}} = 0\text{ V}$, $V_{\text{UNDERDRIVE}} = 100\text{ mV}$, $V_{\text{OVERDRIVE}} = 100\text{ mV}$ unless otherwise noted.

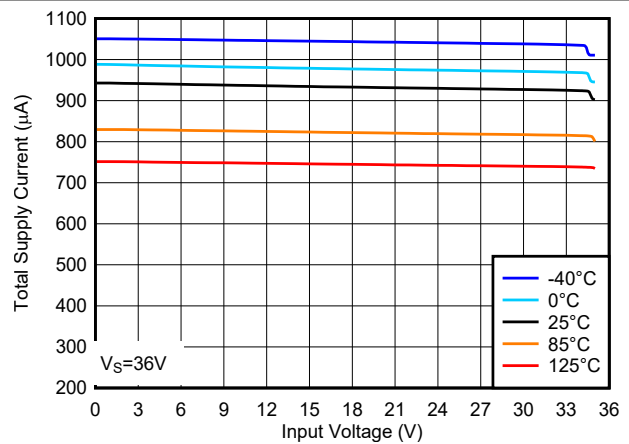

图 7-7. Input Offset Voltage vs. Temperature at 3V



图 7-8. Input Offset Voltage vs. Temperature at 5V

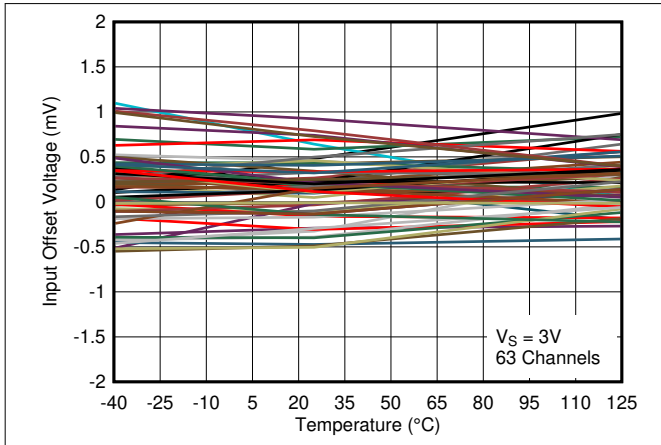

图 7-9. Input Offset Voltage vs. Temperature at 12V

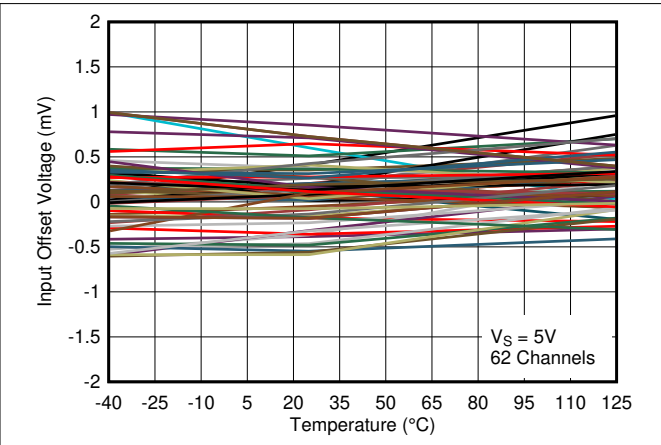

图 7-10. Input Offset Voltage vs. Temperature at 36V

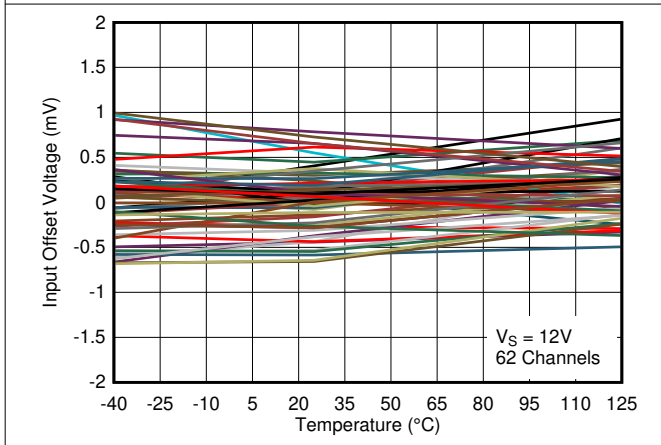

图 7-11. Input Offset Voltage vs. Supply Voltage at -40°C

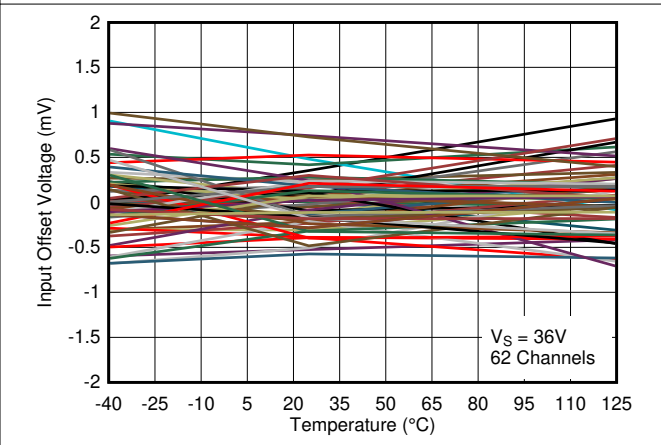

图 7-12. Input Offset Voltage vs. Supply Voltage at 25°C

7.18 Typical Characteristics for LM339B and LM2901B Only (continued)

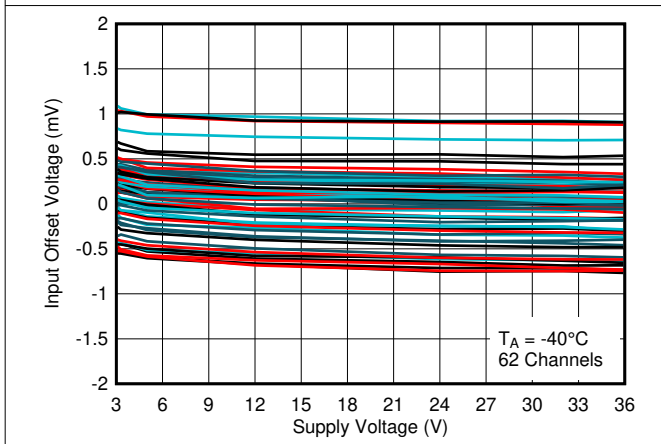
$T_A = 25^\circ\text{C}$, $V_S = 5\text{ V}$, $R_{\text{PULLUP}} = 5.1\text{ k}$, $C_L = 15\text{ pF}$, $V_{\text{CM}} = 0\text{ V}$, $V_{\text{UNDERDRIVE}} = 100\text{ mV}$, $V_{\text{OVERDRIVE}} = 100\text{ mV}$ unless otherwise noted.

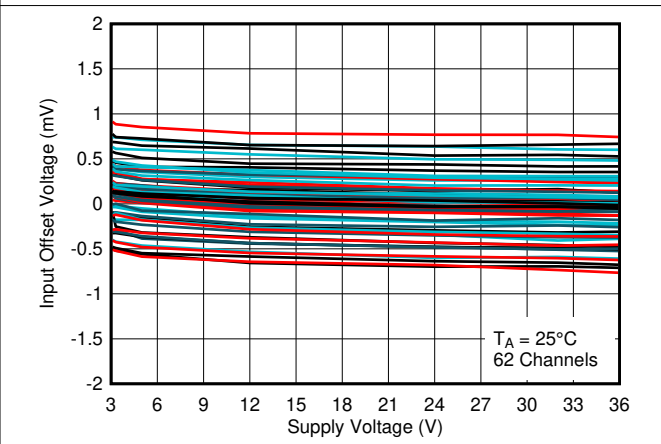

图 7-13. Input Offset Voltage vs. Supply Voltage at 85°C



图 7-14. Input Offset Voltage vs. Supply Voltage at 125°C

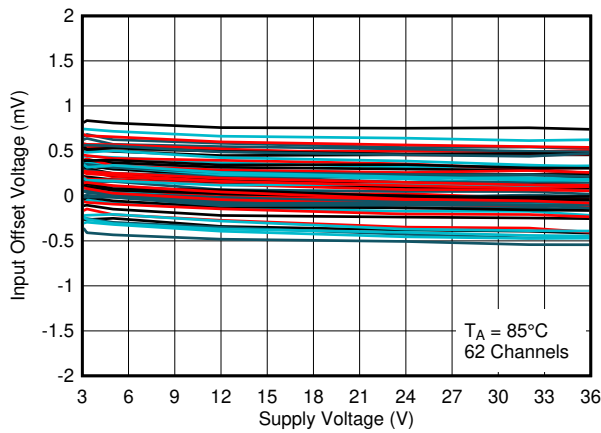

图 7-15. Input Bias Current vs. Supply Voltage

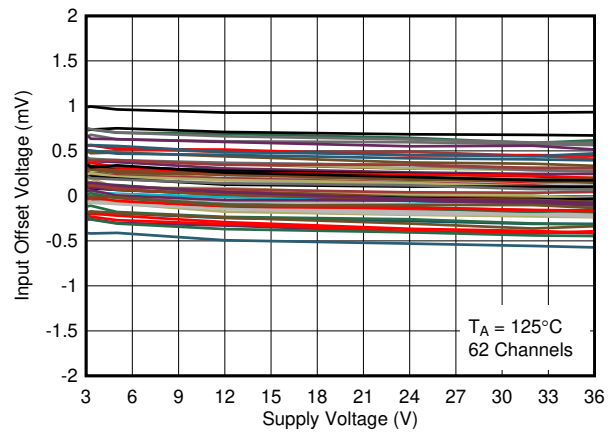

图 7-16. Input Bias Current vs. Input Voltage at 5V

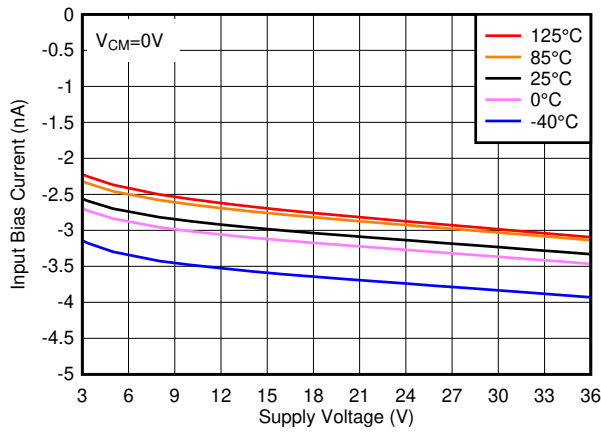

图 7-17. Input Bias Current vs. Input Voltage at 12V

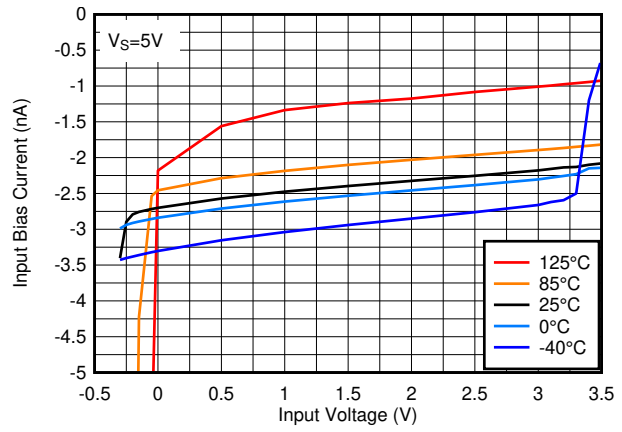

图 7-18. Input Bias Current vs. Input Voltage at 36V

7.18 Typical Characteristics for LM339B and LM2901B Only (continued)

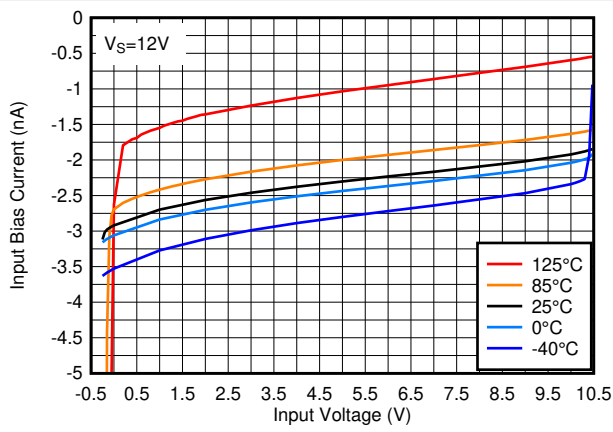
$T_A = 25^\circ\text{C}$, $V_S = 5\text{ V}$, $R_{\text{PULLUP}} = 5.1\text{ k}$, $C_L = 15\text{ pF}$, $V_{\text{CM}} = 0\text{ V}$, $V_{\text{UNDERDRIVE}} = 100\text{ mV}$, $V_{\text{OVERDRIVE}} = 100\text{ mV}$ unless otherwise noted.

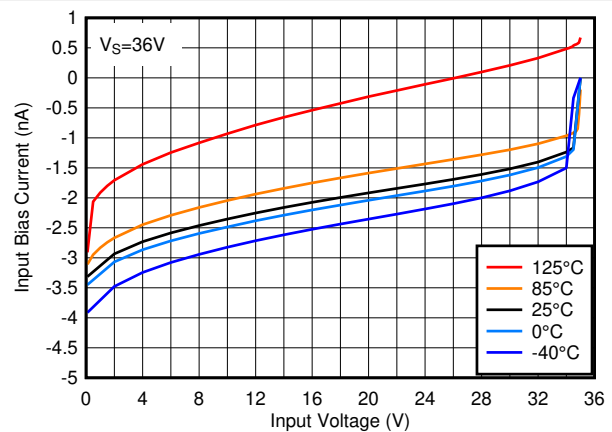

图 7-19. Output Low Voltage vs. Output Sinking Current at 3V



图 7-20. Output Low Voltage vs. Output Sinking Current at 5V

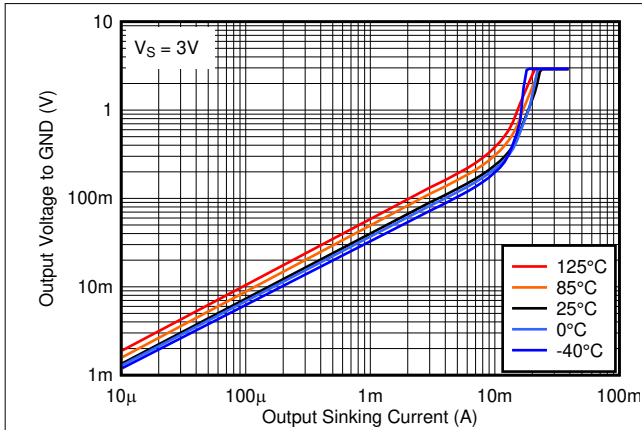

图 7-21. Output Low Voltage vs. Output Sinking Current at 12V

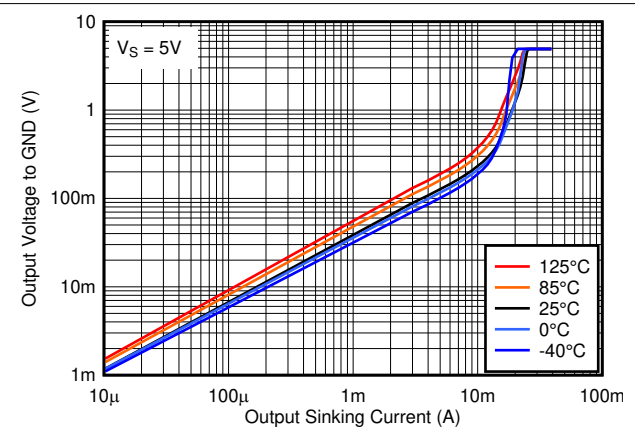

图 7-22. Output Low Voltage vs. Output Sinking Current at 36V

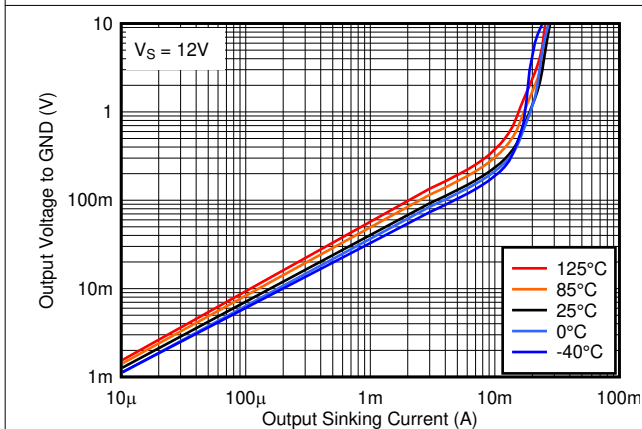

图 7-23. Output High Leakage Current vs. Temperature at 5V

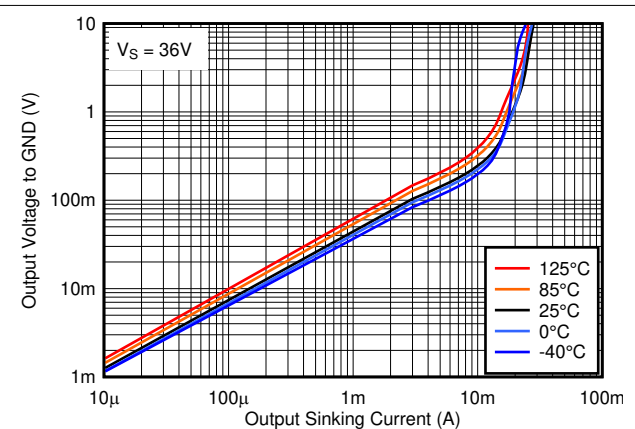

图 7-24. Output High Leakage Current vs. Temperature at 36V

7.18 Typical Characteristics for LM339B and LM2901B Only (continued)

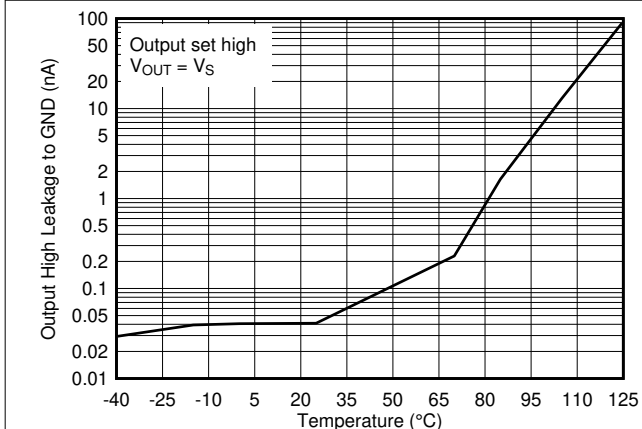
$T_A = 25^\circ\text{C}$, $V_S = 5\text{ V}$, $R_{\text{PULLUP}} = 5.1\text{ k}$, $C_L = 15\text{ pF}$, $V_{\text{CM}} = 0\text{ V}$, $V_{\text{UNDERDRIVE}} = 100\text{ mV}$, $V_{\text{OVERDRIVE}} = 100\text{ mV}$ unless otherwise noted.

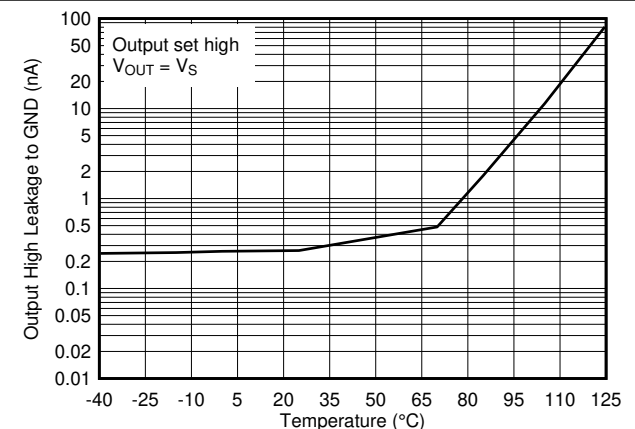

图 7-25. High to Low Propagation Delay vs. Input Overdrive Voltage, 5V



图 7-26. Low to High Propagation Delay vs. Input Overdrive Voltage, 5V

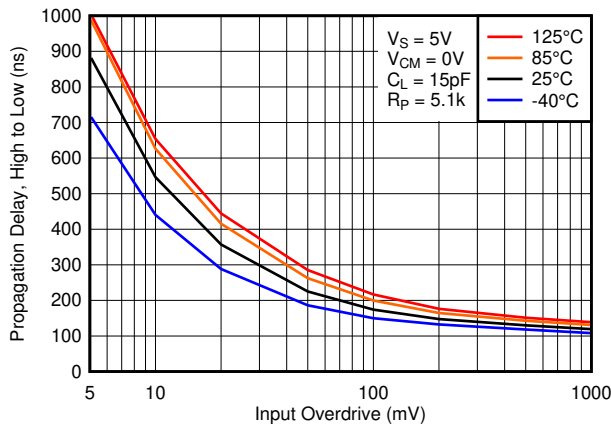

图 7-27. High to Low Propagation Delay vs. Input Overdrive Voltage, 12V

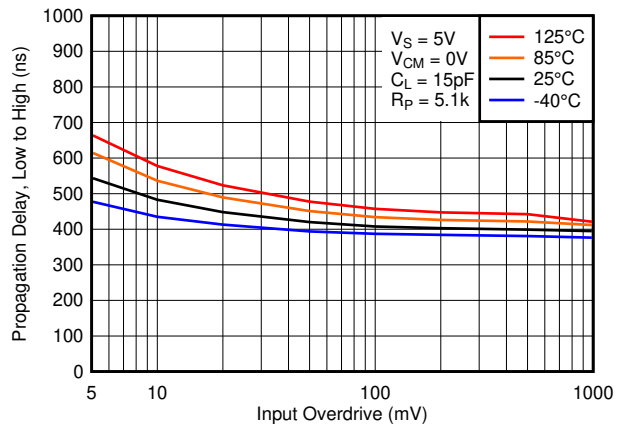

图 7-28. Low to High Propagation Delay vs. Input Overdrive Voltage, 12V

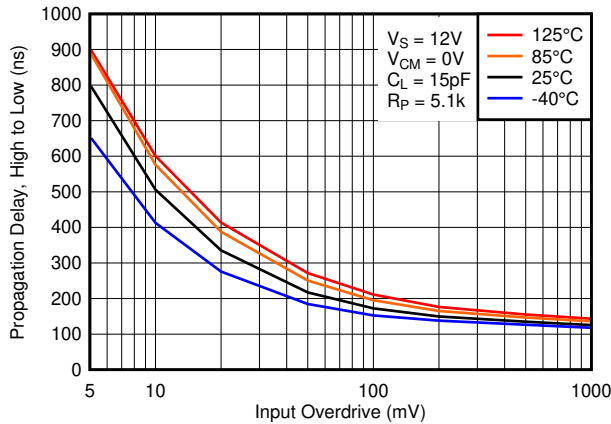

图 7-29. High to Low Propagation Delay vs. Input Overdrive Voltage, 36V

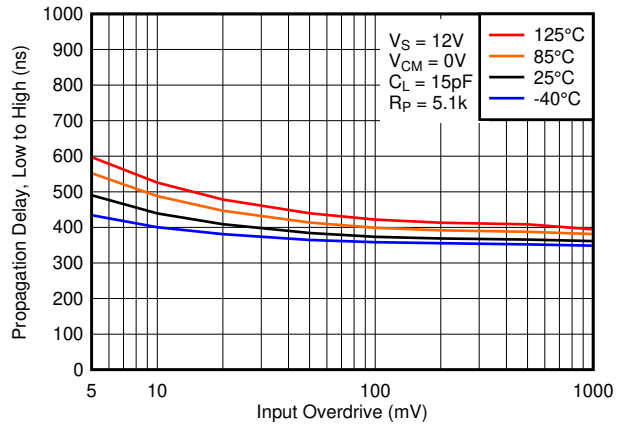

图 7-30. Low to High Propagation Delay vs. Input Overdrive Voltage, 36V

7.18 Typical Characteristics for LM339B and LM2901B Only (continued)

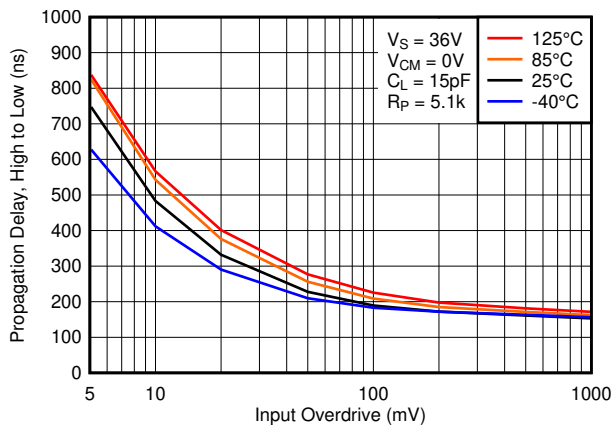
$T_A = 25^\circ\text{C}$, $V_S = 5\text{ V}$, $R_{\text{PULLUP}} = 5.1\text{ k}$, $C_L = 15\text{ pF}$, $V_{\text{CM}} = 0\text{ V}$, $V_{\text{UNDERDRIVE}} = 100\text{ mV}$, $V_{\text{OVERDRIVE}} = 100\text{ mV}$ unless otherwise noted.

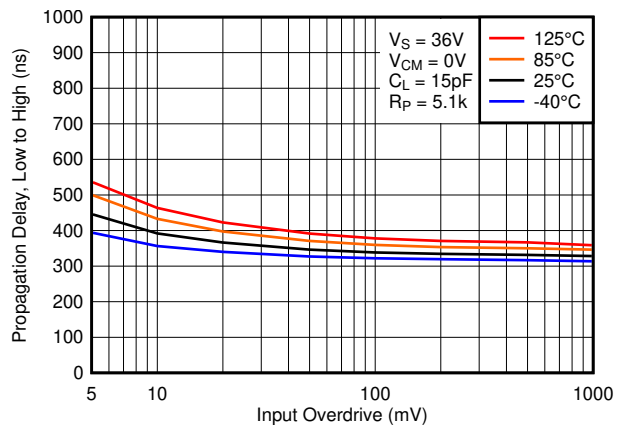

图 7-31. Response Time for Various Overdrives, High-to-Low Transition



图 7-32. Response Time for Various Overdrives, Low-to-High Transition

7.19 Typical Characteristics, Non-B Versions

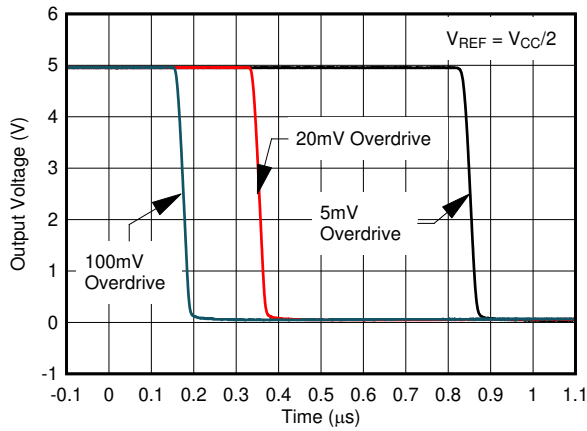

图 7-33. Supply Current vs Supply Voltage

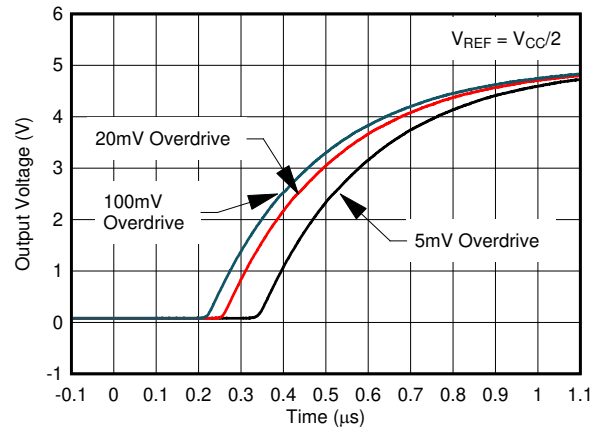

图 7-34. Input Bias Current vs Supply Voltage

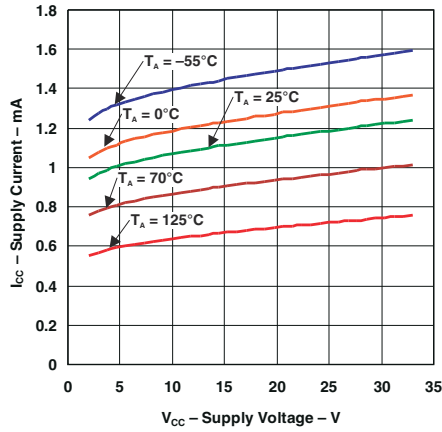

图 7-35. Output Saturation Voltage

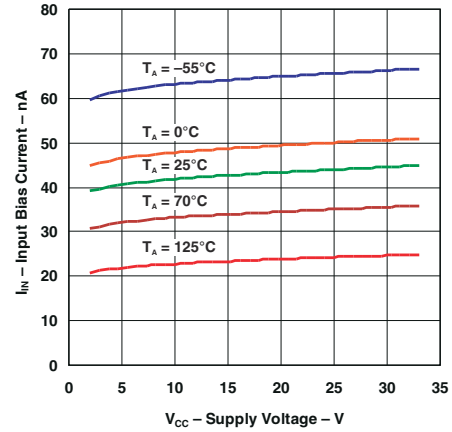

图 7-36. Response Time for Various Overdrives Negative Transition

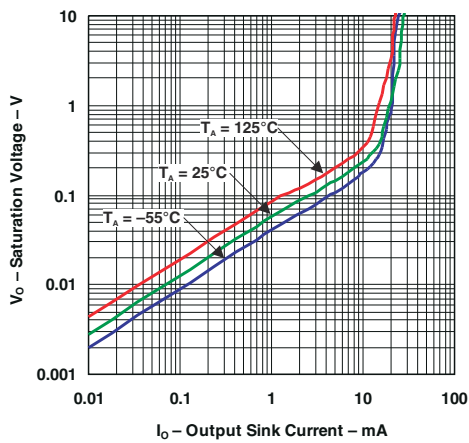

图 7-37. Response Time for Various Overdrives Positive Transition

8 Detailed Description

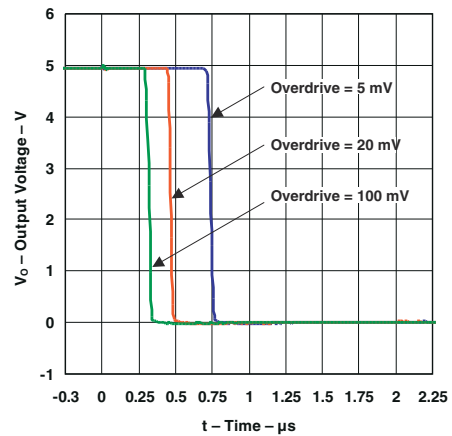
8.1 Overview

The LMx39 and LM2901x are quad comparators with the ability to operate up to an absolute maximum of 36 V on the supply pin. This standard device has proven ubiquity and versatility across a wide range of applications. This is due to very wide supply voltages range (2 V up to 32 V), low I_q , and fast response of the device.

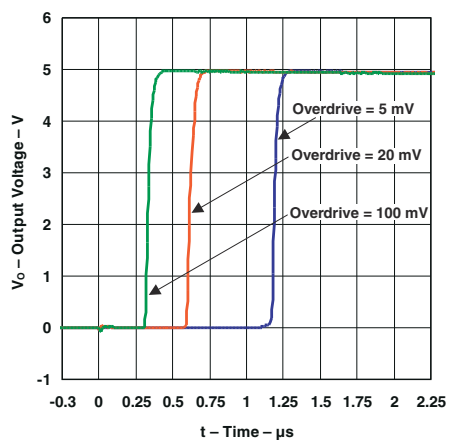
The open-drain output allows the user to configure the output logic low voltage (V_{OL}) and allows the comparator to be used in AND functionality.

8.2 Functional Block Diagram



图 8-1. Schematic (Each Comparator)

8.3 Feature Description

The comparator consists of a PNP Darlington pair input, allowing the device to operate with very high gain and fast response with minimal input bias current. The input Darlington pair creates a limit on the input common-mode voltage capability, allowing the comparator to accurately function from ground to ($V_{CC} - 1.5 V$) differential input. Allow for ($V_{CC} - 2 V$) at cold temperature.

The output consists of an open-collector NPN (pulldown or low-side) transistor. The output NPN sinks current when the negative input voltage is higher than the positive input voltage and the offset voltage. The V_{OL} is resistive and scales with the output current. See the 节 7 section for V_{OL} values with respect to the output current.

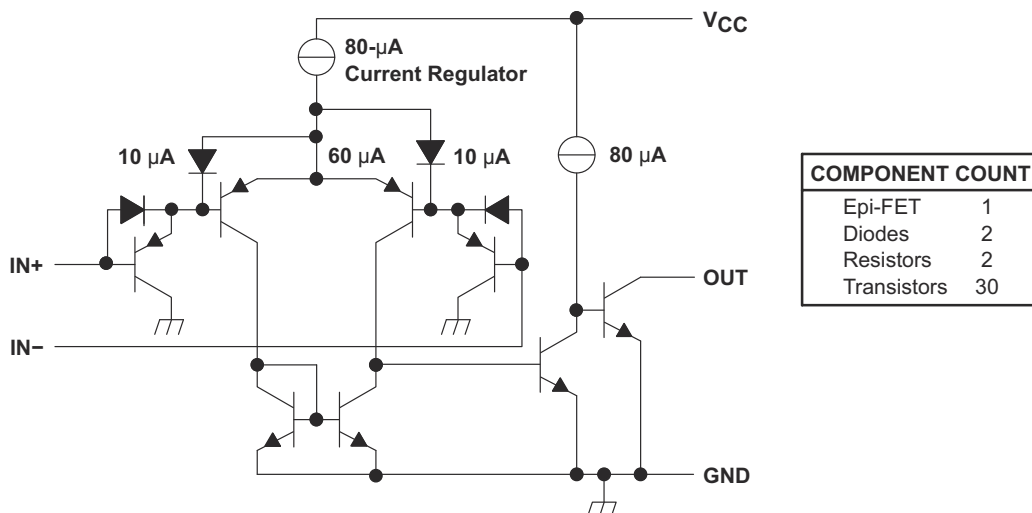
8.4 Device Functional Modes

8.4.1 Voltage Comparison

The comparator operates solely as a voltage comparator, comparing the differential voltage between the positive and negative pins and outputting a logic low or high impedance (logic high with pullup) based on the input differential polarity.

9 Application and Implementation

备注

以下应用部分中的信息不属于 TI 器件规格的范围，TI 不担保其准确性和完整性。TI 的客户应负责确定器件是否适用于其应用。客户应验证并测试其设计，以确保系统功能。

9.1 Application Information

Typically, a comparator compares either a single signal to a reference, or to two different signals. Many users take advantage of the open-drain output to drive the comparison logic output to a logic voltage level to an MCU or logic device. The wide supply range and high voltage capability makes LMx39 or LM2901x optimal for level shifting to a higher or lower voltage.

9.2 Typical Application



图 9-1. Single-ended and Differential Comparator Configurations

9.2.1 Design Requirements

For this design example, use the parameters listed in 表 9-1 as the input parameters.

表 9-1. Design Parameters

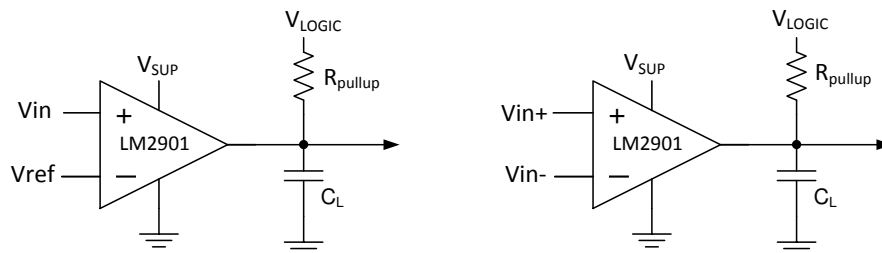
| DESIGN PARAMETER | EXAMPLE VALUE |
|---------------------------------|---------------------------|
| Input Voltage Range | 0 V to $V_{sup}-1.5$ V |
| Supply Voltage | 4.5 V to V_{CC} maximum |
| Logic Supply Voltage | 0 V to V_{CC} maximum |
| Output Current (R_{PULLUP}) | 1 μ A to 4 mA |
| Input Overdrive Voltage | 100 mV |
| Reference Voltage | 2.5 V |
| Load Capacitance (C_L) | 15 pF |

9.2.2 Detailed Design Procedure

When using the LMx39 in a general comparator application, determine the following:

- Input voltage range
- Minimum overdrive voltage
- Output and drive current
- Response time

9.2.2.1 Input Voltage Range

When choosing the input voltage range, the input common-mode voltage range (V_{ICR}) must be taken in to account. If temperature operation is above or below 25°C the V_{ICR} can range from 0 V to $V_{CC} - 2$ V. This limits the input voltage range to as high as $V_{CC} - 2$ V and as low as 0 V. Operation outside of this range can yield incorrect comparisons.

The following list describes the outcomes of some input voltage situations.

- When both IN⁻ and IN⁺ are both within the common-mode range:
 - If IN⁻ is higher than IN⁺ and the offset voltage, the output is low and the output transistor is sinking current
 - If IN⁻ is lower than IN⁺ and the offset voltage, the output is high impedance and the output transistor is not conducting
- When IN⁻ is higher than common mode and IN⁺ is within common mode, the output is low and the output transistor is sinking current
- When IN⁺ is higher than common mode and IN⁻ is within common mode, the output is high impedance and the output transistor is not conducting
- When IN⁻ and IN⁺ are both higher than common mode, the output is low and the output transistor is sinking current

9.2.2.2 Minimum Overdrive Voltage

Overdrive voltage is the differential voltage produced between the positive and negative inputs of the comparator over the offset voltage (V_{IO}). To make an accurate comparison, the overdrive voltage (V_{OD}) must be higher than the input offset voltage (V_{IO}). Overdrive voltage can also determine the response time of the comparator, with the response time decreasing with increasing overdrive. 图 9-2 and 图 9-3 show positive and negative response times with respect to overdrive voltage.

9.2.2.3 Output and Drive Current

Output current is determined by the load and pullup resistance and logic and pullup voltage. The output current produces a low-level output voltage (V_{OL}) from the comparator, where V_{OL} is proportional to the output current.

The output current can also effect the transient response.

9.2.2.4 Response Time

Response time is a function of input over-drive. See the 图 7.19 graphs for typical response times. The rise and fall times can be determined by the load capacitance (C_L), load/pull-up resistance (R_{PULLUP}) and equivalent collector-emitter resistance (R_{CE}).

- The rise time (τ_R) is approximately $\tau_R \sim R_{PULLUP} \times C_L$
- The fall time (τ_F) is approximately $\tau_F \sim R_{CE} \times C_L$
 - R_{CE} can be determined by taking the slope of 图 7-35 in its linear region at the desired temperature, or by dividing the V_{OL} by I_{OUT}

9.2.3 Application Curves

图 9-2 和 图 9-3 were generated with scope probe parasitic capacitance of 50 pF.

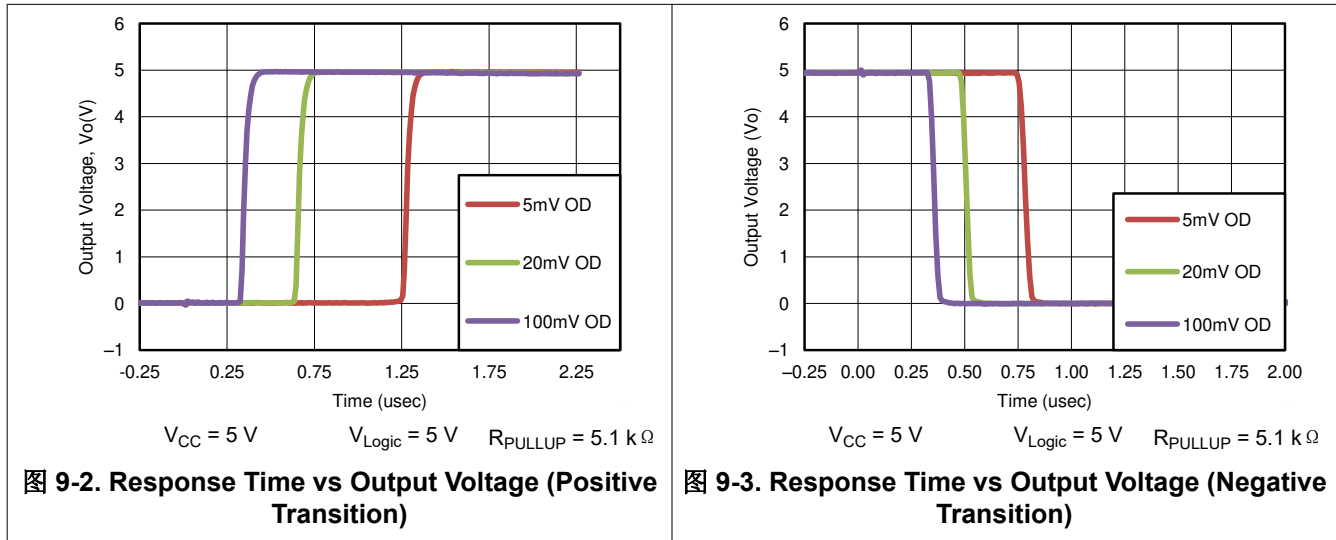

10 Power Supply Recommendations

For fast response and comparison applications with noisy or AC inputs, use a bypass capacitor on the supply pin to reject any variation on the supply voltage. This variation can affect the common-mode range of the comparator input and create an inaccurate comparison.

11 Layout

11.1 Layout Guidelines

To create an accurate comparator application without hysteresis, maintain a stable power supply with minimized noise and glitches, which can affect the high level input common-mode voltage range. To achieve this accuracy, add a bypass capacitor between the supply voltage and ground. Place a bypass capacitor on the positive power supply and negative supply (if available).

备注

If a negative supply is not being used, do not place a capacitor between the GND pin of the device and system ground.

11.2 Layout Example



图 11-1. LMx39 Layout Example

12 Device and Documentation Support

12.1 Related Links

The table below lists quick access links. Categories include technical documents, support and community resources, tools and software, and quick access to sample or buy.

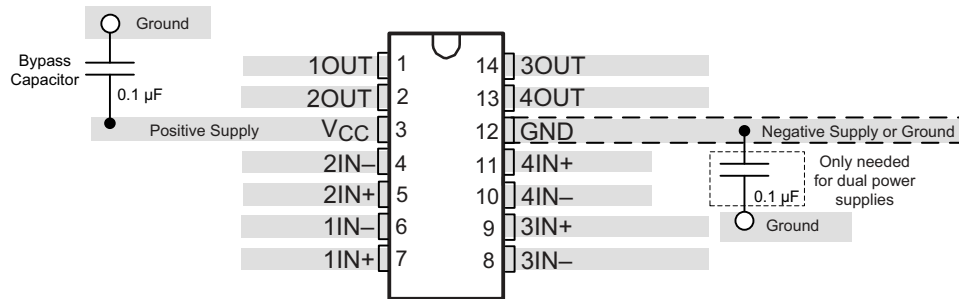
表 12-1. Related Links

| PARTS | PRODUCT FOLDER | SAMPLE & BUY | TECHNICAL DOCUMENTS | TOOLS & SOFTWARE | SUPPORT & COMMUNITY |
|----------|----------------------------|----------------------------|----------------------------|----------------------------|----------------------------|
| LM139 | Click here | Click here | Click here | Click here | Click here |
| LM239 | Click here | Click here | Click here | Click here | Click here |
| LM339 | Click here | Click here | Click here | Click here | Click here |
| LM139A | Click here | Click here | Click here | Click here | Click here |
| LM239A | Click here | Click here | Click here | Click here | Click here |
| LM339A | Click here | Click here | Click here | Click here | Click here |
| LM2901 | Click here | Click here | Click here | Click here | Click here |
| LM2901AV | Click here | Click here | Click here | Click here | Click here |
| LM2901V | Click here | Click here | Click here | Click here | Click here |

12.2 Receiving Notification of Documentation Updates

To receive notification of documentation updates, navigate to the device product folder on ti.com. In the upper right corner, click on *Alert me* to register and receive a weekly digest of any product information that has changed. For change details, review the revision history included in any revised document.

12.3 支持资源

TI E2E™ 支持论坛是工程师的重要参考资料，可直接从专家获得快速、经过验证的解答和设计帮助。搜索现有解答或提出自己的问题可获得所需的快速设计帮助。

链接的内容由各个贡献者“按原样”提供。这些内容并不构成 TI 技术规范，并且不一定反映 TI 的观点；请参阅 TI 的《使用条款》。

12.4 Trademarks

TI E2E™ is a trademark of Texas Instruments.

所有商标均为其各自所有者的财产。

12.5 Electrostatic Discharge Caution



This integrated circuit can be damaged by ESD. Texas Instruments recommends that all integrated circuits be handled with appropriate precautions. Failure to observe proper handling and installation procedures can cause damage.

ESD damage can range from subtle performance degradation to complete device failure. Precision integrated circuits may be more susceptible to damage because very small parametric changes could cause the device not to meet its published specifications.

12.6 术语表

TI 术语表

本术语表列出并解释了术语、首字母缩略词和定义。

13 Mechanical, Packaging, and Orderable Information

The following pages include mechanical packaging and orderable information. This information is the most current data available for the designated devices. This data is subject to change without notice and revision of this document. For browser based versions of this data sheet, refer to the left hand navigation.

PACKAGING INFORMATION

| Orderable Device | Status (1) | Package Type | Package Drawing | Pins | Package Qty | Eco Plan (2) | Lead finish/ Ball material (6) | MSL Peak Temp (3) | Op Temp (°C) | Device Marking (4/5) | Samples |
|------------------|---------------|--------------|-----------------|------|-------------|-----------------|--------------------------------------|----------------------|--------------|-------------------------|-------------------------|
| LM139AD | ACTIVE | SOIC | D | 14 | 50 | RoHS & Green | NIPDAU | Level-1-260C-UNLIM | -55 to 125 | LM139A | Samples |
| LM139ADG4 | ACTIVE | SOIC | D | 14 | 50 | RoHS & Green | NIPDAU | Level-1-260C-UNLIM | -55 to 125 | LM139A | Samples |
| LM139ADR | ACTIVE | SOIC | D | 14 | 2500 | RoHS & Green | NIPDAU | Level-1-260C-UNLIM | -55 to 125 | LM139A | Samples |
| LM139ADRG4 | ACTIVE | SOIC | D | 14 | 2500 | RoHS & Green | NIPDAU | Level-1-260C-UNLIM | -55 to 125 | LM139A | Samples |
| LM139D | ACTIVE | SOIC | D | 14 | 50 | RoHS & Green | NIPDAU | Level-1-260C-UNLIM | -55 to 125 | LM139 | Samples |
| LM139DG4 | ACTIVE | SOIC | D | 14 | 50 | RoHS & Green | NIPDAU | Level-1-260C-UNLIM | -55 to 125 | LM139 | Samples |
| LM139DR | ACTIVE | SOIC | D | 14 | 2500 | RoHS & Green | NIPDAU | Level-1-260C-UNLIM | -55 to 125 | LM139 | Samples |
| LM139DRG4 | ACTIVE | SOIC | D | 14 | 2500 | RoHS & Green | NIPDAU | Level-1-260C-UNLIM | -55 to 125 | LM139 | Samples |
| LM239AD | ACTIVE | SOIC | D | 14 | 50 | RoHS & Green | NIPDAU | Level-1-260C-UNLIM | -25 to 85 | LM239A | Samples |
| LM239ADE4 | ACTIVE | SOIC | D | 14 | 50 | RoHS & Green | NIPDAU | Level-1-260C-UNLIM | -25 to 85 | LM239A | Samples |
| LM239ADR | ACTIVE | SOIC | D | 14 | 2500 | RoHS & Green | NIPDAU SN | Level-1-260C-UNLIM | -25 to 85 | LM239A | Samples |
| LM239ADRE4 | LIFEBUY | SOIC | D | 14 | 2500 | RoHS & Green | NIPDAU | Level-1-260C-UNLIM | -25 to 85 | LM239A | |
| LM239ADRG4 | LIFEBUY | SOIC | D | 14 | 2500 | RoHS & Green | NIPDAU | Level-1-260C-UNLIM | -25 to 85 | LM239A | |
| LM239D | ACTIVE | SOIC | D | 14 | 50 | RoHS & Green | NIPDAU | Level-1-260C-UNLIM | -25 to 85 | LM239 | Samples |
| LM239DE4 | ACTIVE | SOIC | D | 14 | 50 | RoHS & Green | NIPDAU | Level-1-260C-UNLIM | -25 to 85 | LM239 | Samples |
| LM239DG4 | ACTIVE | SOIC | D | 14 | 50 | RoHS & Green | NIPDAU | Level-1-260C-UNLIM | -25 to 85 | LM239 | Samples |
| LM239DR | ACTIVE | SOIC | D | 14 | 2500 | RoHS & Green | NIPDAU SN | Level-1-260C-UNLIM | -25 to 85 | LM239 | Samples |
| LM239DRG3 | ACTIVE | SOIC | D | 14 | 2500 | RoHS & Green | SN | Level-1-260C-UNLIM | -25 to 85 | LM239 | Samples |
| LM239DRG4 | ACTIVE | SOIC | D | 14 | 2500 | RoHS & Green | NIPDAU | Level-1-260C-UNLIM | -25 to 85 | LM239 | Samples |
| LM239N | ACTIVE | PDIP | N | 14 | 25 | RoHS & Green | NIPDAU SN | N / A for Pkg Type | -25 to 85 | LM239N | Samples |
| LM239NE4 | LIFEBUY | PDIP | N | 14 | 25 | RoHS & Green | NIPDAU | N / A for Pkg Type | -25 to 85 | LM239N | |

| Orderable Device | Status (1) | Package Type | Package Drawing | Pins | Package Qty | Eco Plan (2) | Lead finish/ Ball material (6) | MSL Peak Temp (3) | Op Temp (°C) | Device Marking (4/5) | Samples |
|------------------|---------------|--------------|-----------------|------|-------------|-----------------|--------------------------------------|----------------------|--------------|-------------------------|-------------------------|
| LM239PW | ACTIVE | TSSOP | PW | 14 | 90 | RoHS & Green | NIPDAU | Level-1-260C-UNLIM | -25 to 85 | L239 | Samples |
| LM239PWR | ACTIVE | TSSOP | PW | 14 | 2000 | RoHS & Green | NIPDAU SN | Level-1-260C-UNLIM | -25 to 85 | L239 | Samples |
| LM239PWRG4 | LIFEBUY | TSSOP | PW | 14 | 2000 | RoHS & Green | NIPDAU | Level-1-260C-UNLIM | -25 to 85 | L239 | |
| LM2901AVQDR | ACTIVE | SOIC | D | 14 | 2500 | RoHS & Green | NIPDAU | Level-1-260C-UNLIM | -40 to 125 | L2901AV | Samples |
| LM2901AVQDRG4 | ACTIVE | SOIC | D | 14 | 2500 | RoHS & Green | NIPDAU | Level-1-260C-UNLIM | -40 to 125 | L2901AV | Samples |
| LM2901AVQPWR | ACTIVE | TSSOP | PW | 14 | 2000 | RoHS & Green | NIPDAU | Level-1-260C-UNLIM | -40 to 125 | L2901AV | Samples |
| LM2901AVQPWRG4 | ACTIVE | TSSOP | PW | 14 | 2000 | RoHS & Green | NIPDAU | Level-1-260C-UNLIM | -40 to 125 | L2901AV | Samples |
| LM2901BIPWR | ACTIVE | TSSOP | PW | 14 | 3000 | RoHS & Green | NIPDAU | Level-1-260C-UNLIM | -40 to 125 | LM2901B | Samples |
| LM2901D | ACTIVE | SOIC | D | 14 | 50 | RoHS & Green | NIPDAU | Level-1-260C-UNLIM | -40 to 125 | LM2901 | Samples |
| LM2901DE4 | ACTIVE | SOIC | D | 14 | 50 | RoHS & Green | NIPDAU | Level-1-260C-UNLIM | -40 to 125 | LM2901 | Samples |
| LM2901DG4 | ACTIVE | SOIC | D | 14 | 50 | RoHS & Green | NIPDAU | Level-1-260C-UNLIM | -40 to 125 | LM2901 | Samples |
| LM2901DR | ACTIVE | SOIC | D | 14 | 2500 | RoHS & Green | NIPDAU SN | Level-1-260C-UNLIM | -40 to 125 | LM2901 | Samples |
| LM2901DRE4 | LIFEBUY | SOIC | D | 14 | 2500 | RoHS & Green | NIPDAU | Level-1-260C-UNLIM | -40 to 125 | LM2901 | |
| LM2901DRG3 | ACTIVE | SOIC | D | 14 | 2500 | RoHS & Green | SN | Level-1-260C-UNLIM | -40 to 125 | LM2901 | Samples |
| LM2901DRG4 | LIFEBUY | SOIC | D | 14 | 2500 | RoHS & Green | NIPDAU | Level-1-260C-UNLIM | -40 to 125 | LM2901 | |
| LM2901N | ACTIVE | PDIP | N | 14 | 25 | RoHS & Green | NIPDAU | N / A for Pkg Type | -40 to 125 | LM2901N | Samples |
| LM2901NE4 | LIFEBUY | PDIP | N | 14 | 25 | RoHS & Green | NIPDAU | N / A for Pkg Type | -40 to 125 | LM2901N | |
| LM2901NSR | ACTIVE | SO | NS | 14 | 2000 | RoHS & Green | NIPDAU | Level-1-260C-UNLIM | -40 to 125 | LM2901 | Samples |
| LM2901PW | ACTIVE | TSSOP | PW | 14 | 90 | RoHS & Green | NIPDAU | Level-1-260C-UNLIM | -40 to 125 | L2901 | Samples |
| LM2901PWG4 | ACTIVE | TSSOP | PW | 14 | 90 | RoHS & Green | NIPDAU | Level-1-260C-UNLIM | -40 to 125 | L2901 | Samples |
| LM2901PWR | ACTIVE | TSSOP | PW | 14 | 2000 | RoHS & Green | NIPDAU SN | Level-1-260C-UNLIM | -40 to 125 | L2901 | Samples |
| LM2901PWRG3 | ACTIVE | TSSOP | PW | 14 | 2000 | RoHS & Green | SN | Level-1-260C-UNLIM | -40 to 125 | L2901 | Samples |

| Orderable Device | Status (1) | Package Type | Package Drawing | Pins | Package Qty | Eco Plan (2) | Lead finish/ Ball material (6) | MSL Peak Temp (3) | Op Temp (°C) | Device Marking (4/5) | Samples |
|------------------|---------------|--------------|-----------------|------|-------------|-----------------|--------------------------------------|----------------------|--------------|-------------------------|-------------------------|
| LM2901PWRG4 | ACTIVE | TSSOP | PW | 14 | 2000 | RoHS & Green | NIPDAU | Level-1-260C-UNLIM | -40 to 125 | L2901 | Samples |
| LM2901VQDR | ACTIVE | SOIC | D | 14 | 2500 | RoHS & Green | NIPDAU | Level-1-260C-UNLIM | -40 to 125 | L2901V | Samples |
| LM2901VQPWR | ACTIVE | TSSOP | PW | 14 | 2000 | RoHS & Green | NIPDAU | Level-1-260C-UNLIM | -40 to 125 | L2901V | Samples |
| LM2901VQPWRG4 | ACTIVE | TSSOP | PW | 14 | 2000 | RoHS & Green | NIPDAU | Level-1-260C-UNLIM | -40 to 125 | L2901V | Samples |
| LM339AD | ACTIVE | SOIC | D | 14 | 50 | RoHS & Green | NIPDAU | Level-1-260C-UNLIM | 0 to 70 | LM339A | Samples |
| LM339ADBR | ACTIVE | SSOP | DB | 14 | 2000 | RoHS & Green | NIPDAU | Level-1-260C-UNLIM | 0 to 70 | L339A | Samples |
| LM339ADE4 | ACTIVE | SOIC | D | 14 | 50 | RoHS & Green | NIPDAU | Level-1-260C-UNLIM | 0 to 70 | LM339A | Samples |
| LM339ADG4 | ACTIVE | SOIC | D | 14 | 50 | RoHS & Green | NIPDAU | Level-1-260C-UNLIM | 0 to 70 | LM339A | Samples |
| LM339ADR | ACTIVE | SOIC | D | 14 | 2500 | RoHS & Green | NIPDAU SN | Level-1-260C-UNLIM | 0 to 70 | LM339A | Samples |
| LM339ADRE4 | LIFEBUY | SOIC | D | 14 | 2500 | RoHS & Green | NIPDAU | Level-1-260C-UNLIM | 0 to 70 | LM339A | |
| LM339ADRG4 | LIFEBUY | SOIC | D | 14 | 2500 | RoHS & Green | NIPDAU | Level-1-260C-UNLIM | 0 to 70 | LM339A | |
| LM339AN | ACTIVE | PDIP | N | 14 | 25 | RoHS & Green | NIPDAU SN | N / A for Pkg Type | 0 to 70 | LM339AN | Samples |
| LM339ANE4 | LIFEBUY | PDIP | N | 14 | 25 | RoHS & Green | NIPDAU | N / A for Pkg Type | 0 to 70 | LM339AN | |
| LM339ANSR | ACTIVE | SO | NS | 14 | 2000 | RoHS & Green | NIPDAU | Level-1-260C-UNLIM | 0 to 70 | LM339A | Samples |
| LM339ANSRG4 | LIFEBUY | SO | NS | 14 | 2000 | RoHS & Green | NIPDAU | Level-1-260C-UNLIM | 0 to 70 | LM339A | |
| LM339APW | ACTIVE | TSSOP | PW | 14 | 90 | RoHS & Green | NIPDAU | Level-1-260C-UNLIM | 0 to 70 | L339A | Samples |
| LM339APWG4 | ACTIVE | TSSOP | PW | 14 | 90 | RoHS & Green | NIPDAU | Level-1-260C-UNLIM | 0 to 70 | L339A | Samples |
| LM339APWR | ACTIVE | TSSOP | PW | 14 | 2000 | RoHS & Green | NIPDAU SN | Level-1-260C-UNLIM | 0 to 70 | L339A | Samples |
| LM339APWRG4 | ACTIVE | TSSOP | PW | 14 | 2000 | RoHS & Green | NIPDAU | Level-1-260C-UNLIM | 0 to 70 | L339A | Samples |
| LM339BIPWR | ACTIVE | TSSOP | PW | 14 | 3000 | RoHS & Green | NIPDAU | Level-1-260C-UNLIM | -40 to 85 | LM339B | Samples |
| LM339D | ACTIVE | SOIC | D | 14 | 50 | RoHS & Green | NIPDAU | Level-1-260C-UNLIM | 0 to 70 | LM339 | Samples |
| LM339DBR | ACTIVE | SSOP | DB | 14 | 2000 | RoHS & Green | NIPDAU | Level-1-260C-UNLIM | 0 to 70 | LM339 | Samples |

| Orderable Device | Status (1) | Package Type | Package Drawing | Pins | Package Qty | Eco Plan (2) | Lead finish/ Ball material (6) | MSL Peak Temp (3) | Op Temp (°C) | Device Marking (4/5) | Samples |
|------------------|---------------|--------------|-----------------|------|-------------|------------------|--------------------------------------|----------------------|--------------|-------------------------|-------------------------|
| LM339DE4 | ACTIVE | SOIC | D | 14 | 50 | RoHS & Green | NIPDAU | Level-1-260C-UNLIM | 0 to 70 | LM339 | Samples |
| LM339DG4 | ACTIVE | SOIC | D | 14 | 50 | RoHS & Green | NIPDAU | Level-1-260C-UNLIM | 0 to 70 | LM339 | Samples |
| LM339DR | ACTIVE | SOIC | D | 14 | 2500 | RoHS & Green | NIPDAU SN | Level-1-260C-UNLIM | 0 to 70 | LM339 | Samples |
| LM339DRE4 | LIFEBUY | SOIC | D | 14 | 2500 | RoHS & Green | NIPDAU | Level-1-260C-UNLIM | 0 to 70 | LM339 | |
| LM339DRG3 | ACTIVE | SOIC | D | 14 | 2500 | RoHS & Green | SN | Level-1-260C-UNLIM | 0 to 70 | LM339 | Samples |
| LM339DRG4 | LIFEBUY | SOIC | D | 14 | 2500 | RoHS & Green | NIPDAU | Level-1-260C-UNLIM | 0 to 70 | LM339 | |
| LM339N | ACTIVE | PDIP | N | 14 | 25 | RoHS & Green | NIPDAU SN | N / A for Pkg Type | 0 to 70 | LM339N | Samples |
| LM339NE3 | ACTIVE | PDIP | N | 14 | 25 | RoHS & Non-Green | SN | N / A for Pkg Type | 0 to 70 | LM339N | Samples |
| LM339NE4 | ACTIVE | PDIP | N | 14 | 25 | RoHS & Green | NIPDAU | N / A for Pkg Type | 0 to 70 | LM339N | Samples |
| LM339NSR | ACTIVE | SO | NS | 14 | 2000 | RoHS & Green | NIPDAU | Level-1-260C-UNLIM | 0 to 70 | LM339 | Samples |
| LM339NSRG4 | LIFEBUY | SO | NS | 14 | 2000 | RoHS & Green | NIPDAU | Level-1-260C-UNLIM | 0 to 70 | LM339 | |
| LM339PW | ACTIVE | TSSOP | PW | 14 | 90 | RoHS & Green | NIPDAU | Level-1-260C-UNLIM | 0 to 70 | L339 | Samples |
| LM339PWG4 | ACTIVE | TSSOP | PW | 14 | 90 | RoHS & Green | NIPDAU | Level-1-260C-UNLIM | 0 to 70 | L339 | Samples |
| LM339PWR | ACTIVE | TSSOP | PW | 14 | 2000 | RoHS & Green | NIPDAU SN | Level-1-260C-UNLIM | 0 to 70 | L339 | Samples |
| LM339PWRE4 | LIFEBUY | TSSOP | PW | 14 | 2000 | RoHS & Green | NIPDAU | Level-1-260C-UNLIM | 0 to 70 | L339 | |
| LM339PWRG3 | ACTIVE | TSSOP | PW | 14 | 2000 | RoHS & Green | SN | Level-1-260C-UNLIM | 0 to 70 | L339 | Samples |
| LM339PWRG4 | LIFEBUY | TSSOP | PW | 14 | 2000 | RoHS & Green | NIPDAU | Level-1-260C-UNLIM | 0 to 70 | L339 | |
| PLM339BIDR | ACTIVE | SOIC | D | 14 | 3000 | TBD | Call TI | Call TI | -40 to 85 | | Samples |

(1) The marketing status values are defined as follows:

ACTIVE: Product device recommended for new designs.

LIFEBUY: TI has announced that the device will be discontinued, and a lifetime-buy period is in effect.

NRND: Not recommended for new designs. Device is in production to support existing customers, but TI does not recommend using this part in a new design.

PREVIEW: Device has been announced but is not in production. Samples may or may not be available.

OBSELETE: TI has discontinued the production of the device.

(2) **RoHS:** TI defines "RoHS" to mean semiconductor products that are compliant with the current EU RoHS requirements for all 10 RoHS substances, including the requirement that RoHS substance do not exceed 0.1% by weight in homogeneous materials. Where designed to be soldered at high temperatures, "RoHS" products are suitable for use in specified lead-free processes. TI may reference these types of products as "Pb-Free".

RoHS Exempt: TI defines "RoHS Exempt" to mean products that contain lead but are compliant with EU RoHS pursuant to a specific EU RoHS exemption.

Green: TI defines "Green" to mean the content of Chlorine (Cl) and Bromine (Br) based flame retardants meet JS709B low halogen requirements of ≤ 1000 ppm threshold. Antimony trioxide based flame retardants must also meet the ≤ 1000 ppm threshold requirement.

(3) **MSL, Peak Temp.** - The Moisture Sensitivity Level rating according to the JEDEC industry standard classifications, and peak solder temperature.

(4) There may be additional marking, which relates to the logo, the lot trace code information, or the environmental category on the device.

(5) Multiple Device Markings will be inside parentheses. Only one Device Marking contained in parentheses and separated by a "~" will appear on a device. If a line is indented then it is a continuation of the previous line and the two combined represent the entire Device Marking for that device.

(6) **Lead finish/Ball material** - Orderable Devices may have multiple material finish options. Finish options are separated by a vertical ruled line. Lead finish/Ball material values may wrap to two lines if the finish value exceeds the maximum column width.

Important Information and Disclaimer: The information provided on this page represents TI's knowledge and belief as of the date that it is provided. TI bases its knowledge and belief on information provided by third parties, and makes no representation or warranty as to the accuracy of such information. Efforts are underway to better integrate information from third parties. TI has taken and continues to take reasonable steps to provide representative and accurate information but may not have conducted destructive testing or chemical analysis on incoming materials and chemicals. TI and TI suppliers consider certain information to be proprietary, and thus CAS numbers and other limited information may not be available for release.

In no event shall TI's liability arising out of such information exceed the total purchase price of the TI part(s) at issue in this document sold by TI to Customer on an annual basis.

OTHER QUALIFIED VERSIONS OF LM139, LM239A, LM2901, LM2901AV, LM2901B, LM2901V :

● Automotive : [LM239A-Q1](#), [LM2901-Q1](#), [LM2901AV-Q1](#), [LM2901B-Q1](#), [LM2901V-Q1](#)

● Enhanced Product : [LM239A-EP](#)

● Space : [LM139-SP](#)

NOTE: Qualified Version Definitions:

- Automotive - Q100 devices qualified for high-reliability automotive applications targeting zero defects
- Enhanced Product - Supports Defense, Aerospace and Medical Applications

- Space - Radiation tolerant, ceramic packaging and qualified for use in Space-based application

TAPE AND REEL INFORMATION

QUADRANT ASSIGNMENTS FOR PIN 1 ORIENTATION IN TAPE

*All dimensions are nominal

| Device | Package Type | Package Drawing | Pins | SPQ | Reel Diameter (mm) | Reel Width W1 (mm) | A0 (mm) | B0 (mm) | K0 (mm) | P1 (mm) | W (mm) | Pin1 Quadrant |
|----------------|--------------|-----------------|------|------|--------------------|--------------------|---------|---------|---------|---------|--------|---------------|
| LM139ADR | SOIC | D | 14 | 2500 | 330.0 | 16.4 | 6.5 | 9.0 | 2.1 | 8.0 | 16.0 | Q1 |
| LM139DRG4 | SOIC | D | 14 | 2500 | 330.0 | 16.4 | 6.5 | 9.0 | 2.1 | 8.0 | 16.0 | Q1 |
| LM139DR | SOIC | D | 14 | 2500 | 330.0 | 16.4 | 6.5 | 9.0 | 2.1 | 8.0 | 16.0 | Q1 |
| LM139DRG4 | SOIC | D | 14 | 2500 | 330.0 | 16.4 | 6.5 | 9.0 | 2.1 | 8.0 | 16.0 | Q1 |
| LM239ADR | SOIC | D | 14 | 2500 | 330.0 | 16.4 | 6.5 | 9.0 | 2.1 | 8.0 | 16.0 | Q1 |
| LM239DR | SOIC | D | 14 | 2500 | 330.0 | 16.8 | 6.5 | 9.5 | 2.1 | 8.0 | 16.0 | Q1 |
| LM239DR | SOIC | D | 14 | 2500 | 330.0 | 16.4 | 6.5 | 9.0 | 2.1 | 8.0 | 16.0 | Q1 |
| LM239DRG3 | SOIC | D | 14 | 2500 | 330.0 | 16.8 | 6.5 | 9.5 | 2.1 | 8.0 | 16.0 | Q1 |
| LM239DRG3 | SOIC | D | 14 | 2500 | 330.0 | 17.5 | 6.4 | 9.05 | 2.1 | 8.0 | 16.0 | Q1 |
| LM239DRG4 | SOIC | D | 14 | 2500 | 330.0 | 16.4 | 6.5 | 9.0 | 2.1 | 8.0 | 16.0 | Q1 |
| LM239DRG4 | SOIC | D | 14 | 2500 | 330.0 | 16.4 | 6.5 | 9.0 | 2.1 | 8.0 | 16.0 | Q1 |
| LM239PWR | TSSOP | PW | 14 | 2000 | 330.0 | 12.4 | 6.9 | 5.6 | 1.6 | 8.0 | 12.0 | Q1 |
| LM239PWRG4 | TSSOP | PW | 14 | 2000 | 330.0 | 12.4 | 6.9 | 5.6 | 1.6 | 8.0 | 12.0 | Q1 |
| LM2901AVQPWR | TSSOP | PW | 14 | 2000 | 330.0 | 12.4 | 6.9 | 5.6 | 1.6 | 8.0 | 12.0 | Q1 |
| LM2901AVQPWRG4 | TSSOP | PW | 14 | 2000 | 330.0 | 12.4 | 6.9 | 5.6 | 1.6 | 8.0 | 12.0 | Q1 |

| Device | Package Type | Package Drawing | Pins | SPQ | Reel Diameter (mm) | Reel Width W1 (mm) | A0 (mm) | B0 (mm) | K0 (mm) | P1 (mm) | W (mm) | Pin1 Quadrant |
|---------------|--------------|-----------------|------|------|--------------------|--------------------|---------|---------|---------|---------|--------|---------------|
| LM2901BIPWR | TSSOP | PW | 14 | 3000 | 330.0 | 12.4 | 6.9 | 5.6 | 1.6 | 8.0 | 12.0 | Q1 |
| LM2901DR | SOIC | D | 14 | 2500 | 330.0 | 16.4 | 6.5 | 9.0 | 2.1 | 8.0 | 16.0 | Q1 |
| LM2901DR | SOIC | D | 14 | 2500 | 330.0 | 16.8 | 6.5 | 9.5 | 2.1 | 8.0 | 16.0 | Q1 |
| LM2901DRG3 | SOIC | D | 14 | 2500 | 330.0 | 16.8 | 6.5 | 9.5 | 2.1 | 8.0 | 16.0 | Q1 |
| LM2901DRG4 | SOIC | D | 14 | 2500 | 330.0 | 16.4 | 6.5 | 9.0 | 2.1 | 8.0 | 16.0 | Q1 |
| LM2901DRG4 | SOIC | D | 14 | 2500 | 330.0 | 16.4 | 6.5 | 9.0 | 2.1 | 8.0 | 16.0 | Q1 |
| LM2901NSR | SO | NS | 14 | 2000 | 330.0 | 16.4 | 8.2 | 10.5 | 2.5 | 12.0 | 16.0 | Q1 |
| LM2901PWR | TSSOP | PW | 14 | 2000 | 330.0 | 12.4 | 6.9 | 5.6 | 1.6 | 8.0 | 12.0 | Q1 |
| LM2901PWR | TSSOP | PW | 14 | 2000 | 330.0 | 12.4 | 6.9 | 5.6 | 1.6 | 8.0 | 12.0 | Q1 |
| LM2901PWRG3 | TSSOP | PW | 14 | 2000 | 330.0 | 12.4 | 6.9 | 5.6 | 1.6 | 8.0 | 12.0 | Q1 |
| LM2901PWRG4 | TSSOP | PW | 14 | 2000 | 330.0 | 12.4 | 6.9 | 5.6 | 1.6 | 8.0 | 12.0 | Q1 |
| LM2901VQPWR | TSSOP | PW | 14 | 2000 | 330.0 | 12.4 | 6.9 | 5.6 | 1.6 | 8.0 | 12.0 | Q1 |
| LM2901VQPWRG4 | TSSOP | PW | 14 | 2000 | 330.0 | 12.4 | 6.9 | 5.6 | 1.6 | 8.0 | 12.0 | Q1 |
| LM339ADBR | SSOP | DB | 14 | 2000 | 330.0 | 16.4 | 8.35 | 6.6 | 2.4 | 12.0 | 16.0 | Q1 |
| LM339ADR | SOIC | D | 14 | 2500 | 330.0 | 16.4 | 6.5 | 9.0 | 2.1 | 8.0 | 16.0 | Q1 |
| LM339ADR | SOIC | D | 14 | 2500 | 330.0 | 16.8 | 6.5 | 9.5 | 2.1 | 8.0 | 16.0 | Q1 |
| LM339ADRG4 | SOIC | D | 14 | 2500 | 330.0 | 16.4 | 6.5 | 9.0 | 2.1 | 8.0 | 16.0 | Q1 |
| LM339ADRG4 | SOIC | D | 14 | 2500 | 330.0 | 16.4 | 6.5 | 9.0 | 2.1 | 8.0 | 16.0 | Q1 |
| LM339ANSR | SO | NS | 14 | 2000 | 330.0 | 16.4 | 8.2 | 10.5 | 2.5 | 12.0 | 16.0 | Q1 |
| LM339APWR | TSSOP | PW | 14 | 2000 | 330.0 | 12.4 | 6.9 | 5.6 | 1.6 | 8.0 | 12.0 | Q1 |
| LM339APWR | TSSOP | PW | 14 | 2000 | 330.0 | 12.4 | 6.9 | 5.6 | 1.6 | 8.0 | 12.0 | Q1 |
| LM339APWRG4 | TSSOP | PW | 14 | 2000 | 330.0 | 12.4 | 6.9 | 5.6 | 1.6 | 8.0 | 12.0 | Q1 |
| LM339BIPWR | TSSOP | PW | 14 | 3000 | 330.0 | 12.4 | 6.9 | 5.6 | 1.6 | 8.0 | 12.0 | Q1 |
| LM339DBR | SSOP | DB | 14 | 2000 | 330.0 | 16.4 | 8.35 | 6.6 | 2.4 | 12.0 | 16.0 | Q1 |
| LM339DR | SOIC | D | 14 | 2500 | 330.0 | 16.8 | 6.5 | 9.5 | 2.1 | 8.0 | 16.0 | Q1 |
| LM339DR | SOIC | D | 14 | 2500 | 330.0 | 16.4 | 6.5 | 9.0 | 2.1 | 8.0 | 16.0 | Q1 |
| LM339DRG3 | SOIC | D | 14 | 2500 | 330.0 | 16.8 | 6.5 | 9.5 | 2.1 | 8.0 | 16.0 | Q1 |
| LM339DRG3 | SOIC | D | 14 | 2500 | 330.0 | 17.5 | 6.4 | 9.05 | 2.1 | 8.0 | 16.0 | Q1 |
| LM339DRG4 | SOIC | D | 14 | 2500 | 330.0 | 16.4 | 6.5 | 9.0 | 2.1 | 8.0 | 16.0 | Q1 |
| LM339DRG4 | SOIC | D | 14 | 2500 | 330.0 | 16.4 | 6.5 | 9.0 | 2.1 | 8.0 | 16.0 | Q1 |
| LM339NSR | SO | NS | 14 | 2000 | 330.0 | 16.4 | 8.2 | 10.5 | 2.5 | 12.0 | 16.0 | Q1 |
| LM339PWR | TSSOP | PW | 14 | 2000 | 330.0 | 12.4 | 6.9 | 5.6 | 1.6 | 8.0 | 12.0 | Q1 |
| LM339PWRG3 | TSSOP | PW | 14 | 2000 | 330.0 | 12.4 | 6.9 | 5.6 | 1.6 | 8.0 | 12.0 | Q1 |
| LM339PWRG4 | TSSOP | PW | 14 | 2000 | 330.0 | 12.4 | 6.9 | 5.6 | 1.6 | 8.0 | 12.0 | Q1 |

TAPE AND REEL BOX DIMENSIONS

*All dimensions are nominal

| Device | Package Type | Package Drawing | Pins | SPQ | Length (mm) | Width (mm) | Height (mm) |
|----------------|--------------|-----------------|------|------|-------------|------------|-------------|
| LM139ADR | SOIC | D | 14 | 2500 | 350.0 | 350.0 | 43.0 |
| LM139DRG4 | SOIC | D | 14 | 2500 | 350.0 | 350.0 | 43.0 |
| LM139DR | SOIC | D | 14 | 2500 | 350.0 | 350.0 | 43.0 |
| LM139DRG4 | SOIC | D | 14 | 2500 | 350.0 | 350.0 | 43.0 |
| LM239ADR | SOIC | D | 14 | 2500 | 340.5 | 336.1 | 32.0 |
| LM239ADR | SOIC | D | 14 | 2500 | 356.0 | 356.0 | 35.0 |
| LM239DR | SOIC | D | 14 | 2500 | 364.0 | 364.0 | 27.0 |
| LM239DR | SOIC | D | 14 | 2500 | 340.5 | 336.1 | 32.0 |
| LM239DRG3 | SOIC | D | 14 | 2500 | 364.0 | 364.0 | 27.0 |
| LM239DRG3 | SOIC | D | 14 | 2500 | 333.2 | 345.9 | 28.6 |
| LM239DRG4 | SOIC | D | 14 | 2500 | 340.5 | 336.1 | 32.0 |
| LM239DRG4 | SOIC | D | 14 | 2500 | 356.0 | 356.0 | 35.0 |
| LM239PWR | TSSOP | PW | 14 | 2000 | 356.0 | 356.0 | 35.0 |
| LM239PWRG4 | TSSOP | PW | 14 | 2000 | 356.0 | 356.0 | 35.0 |
| LM2901AVQPWR | TSSOP | PW | 14 | 2000 | 356.0 | 356.0 | 35.0 |
| LM2901AVQPWRG4 | TSSOP | PW | 14 | 2000 | 356.0 | 356.0 | 35.0 |
| LM2901BIPWR | TSSOP | PW | 14 | 3000 | 356.0 | 356.0 | 35.0 |
| LM2901DR | SOIC | D | 14 | 2500 | 340.5 | 336.1 | 32.0 |

| Device | Package Type | Package Drawing | Pins | SPQ | Length (mm) | Width (mm) | Height (mm) |
|---------------|--------------|-----------------|------|------|-------------|------------|-------------|
| LM2901DR | SOIC | D | 14 | 2500 | 364.0 | 364.0 | 27.0 |
| LM2901DRG3 | SOIC | D | 14 | 2500 | 364.0 | 364.0 | 27.0 |
| LM2901DRG4 | SOIC | D | 14 | 2500 | 356.0 | 356.0 | 35.0 |
| LM2901DRG4 | SOIC | D | 14 | 2500 | 340.5 | 336.1 | 32.0 |
| LM2901NSR | SO | NS | 14 | 2000 | 356.0 | 356.0 | 35.0 |
| LM2901PWR | TSSOP | PW | 14 | 2000 | 356.0 | 356.0 | 35.0 |
| LM2901PWR | TSSOP | PW | 14 | 2000 | 364.0 | 364.0 | 27.0 |
| LM2901PWRG3 | TSSOP | PW | 14 | 2000 | 364.0 | 364.0 | 27.0 |
| LM2901PWRG4 | TSSOP | PW | 14 | 2000 | 356.0 | 356.0 | 35.0 |
| LM2901VQPWR | TSSOP | PW | 14 | 2000 | 356.0 | 356.0 | 35.0 |
| LM2901VQPWRG4 | TSSOP | PW | 14 | 2000 | 356.0 | 356.0 | 35.0 |
| LM339ADBR | SSOP | DB | 14 | 2000 | 356.0 | 356.0 | 35.0 |
| LM339ADR | SOIC | D | 14 | 2500 | 340.5 | 336.1 | 32.0 |
| LM339ADR | SOIC | D | 14 | 2500 | 364.0 | 364.0 | 27.0 |
| LM339ADRG4 | SOIC | D | 14 | 2500 | 340.5 | 336.1 | 32.0 |
| LM339ADRG4 | SOIC | D | 14 | 2500 | 356.0 | 356.0 | 35.0 |
| LM339ANSR | SO | NS | 14 | 2000 | 356.0 | 356.0 | 35.0 |
| LM339APWR | TSSOP | PW | 14 | 2000 | 356.0 | 356.0 | 35.0 |
| LM339APWR | TSSOP | PW | 14 | 2000 | 364.0 | 364.0 | 27.0 |
| LM339APWRG4 | TSSOP | PW | 14 | 2000 | 356.0 | 356.0 | 35.0 |
| LM339BIPWR | TSSOP | PW | 14 | 3000 | 356.0 | 356.0 | 35.0 |
| LM339DBR | SSOP | DB | 14 | 2000 | 356.0 | 356.0 | 35.0 |
| LM339DR | SOIC | D | 14 | 2500 | 364.0 | 364.0 | 27.0 |
| LM339DR | SOIC | D | 14 | 2500 | 340.5 | 336.1 | 32.0 |
| LM339DRG3 | SOIC | D | 14 | 2500 | 364.0 | 364.0 | 27.0 |
| LM339DRG3 | SOIC | D | 14 | 2500 | 333.2 | 345.9 | 28.6 |
| LM339DRG4 | SOIC | D | 14 | 2500 | 340.5 | 336.1 | 32.0 |
| LM339DRG4 | SOIC | D | 14 | 2500 | 356.0 | 356.0 | 35.0 |
| LM339NSR | SO | NS | 14 | 2000 | 356.0 | 356.0 | 35.0 |
| LM339PWR | TSSOP | PW | 14 | 2000 | 356.0 | 356.0 | 35.0 |
| LM339PWRG3 | TSSOP | PW | 14 | 2000 | 364.0 | 364.0 | 27.0 |
| LM339PWRG4 | TSSOP | PW | 14 | 2000 | 356.0 | 356.0 | 35.0 |

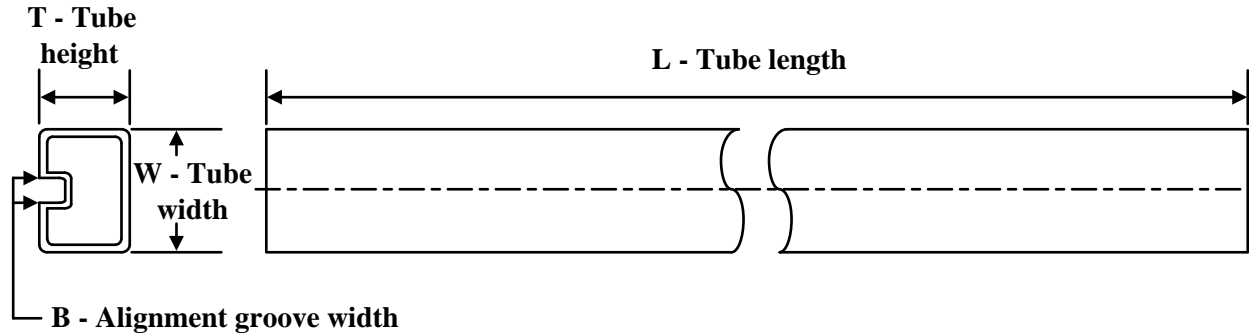
TUBE

*All dimensions are nominal

| Device | Package Name | Package Type | Pins | SPQ | L (mm) | W (mm) | T (μm) | B (mm) |
|------------|--------------|--------------|------|-----|--------|--------|--------|--------|
| LM139AD | D | SOIC | 14 | 50 | 505.46 | 6.76 | 3810 | 4 |
| LM139ADG4 | D | SOIC | 14 | 50 | 505.46 | 6.76 | 3810 | 4 |
| LM139D | D | SOIC | 14 | 50 | 505.46 | 6.76 | 3810 | 4 |
| LM139DG4 | D | SOIC | 14 | 50 | 505.46 | 6.76 | 3810 | 4 |
| LM239AD | D | SOIC | 14 | 50 | 506.6 | 8 | 3940 | 4.32 |
| LM239AD | D | SOIC | 14 | 50 | 507 | 8 | 3940 | 4.32 |
| LM239ADE4 | D | SOIC | 14 | 50 | 506.6 | 8 | 3940 | 4.32 |
| LM239ADE4 | D | SOIC | 14 | 50 | 507 | 8 | 3940 | 4.32 |
| LM239D | D | SOIC | 14 | 50 | 506.6 | 8 | 3940 | 4.32 |
| LM239D | D | SOIC | 14 | 50 | 507 | 8 | 3940 | 4.32 |
| LM239DE4 | D | SOIC | 14 | 50 | 506.6 | 8 | 3940 | 4.32 |
| LM239DE4 | D | SOIC | 14 | 50 | 507 | 8 | 3940 | 4.32 |
| LM239DG4 | D | SOIC | 14 | 50 | 507 | 8 | 3940 | 4.32 |
| LM239DG4 | D | SOIC | 14 | 50 | 506.6 | 8 | 3940 | 4.32 |
| LM239N | N | PDIP | 14 | 25 | 506.1 | 9 | 600 | 5.4 |
| LM239N | N | PDIP | 14 | 25 | 506 | 13.97 | 11230 | 4.32 |
| LM239NE4 | N | PDIP | 14 | 25 | 506.1 | 9 | 600 | 5.4 |
| LM239NE4 | N | PDIP | 14 | 25 | 506 | 13.97 | 11230 | 4.32 |
| LM239PW | PW | TSSOP | 14 | 90 | 530 | 10.2 | 3600 | 3.5 |
| LM2901D | D | SOIC | 14 | 50 | 506.6 | 8 | 3940 | 4.32 |
| LM2901DE4 | D | SOIC | 14 | 50 | 506.6 | 8 | 3940 | 4.32 |
| LM2901DG4 | D | SOIC | 14 | 50 | 506.6 | 8 | 3940 | 4.32 |
| LM2901N | N | PDIP | 14 | 25 | 506 | 13.97 | 11230 | 4.32 |
| LM2901NE4 | N | PDIP | 14 | 25 | 506 | 13.97 | 11230 | 4.32 |
| LM2901PW | PW | TSSOP | 14 | 90 | 530 | 10.2 | 3600 | 3.5 |
| LM2901PWG4 | PW | TSSOP | 14 | 90 | 530 | 10.2 | 3600 | 3.5 |
| LM339AD | D | SOIC | 14 | 50 | 507 | 8 | 3940 | 4.32 |
| LM339AD | D | SOIC | 14 | 50 | 506.6 | 8 | 3940 | 4.32 |
| LM339ADE4 | D | SOIC | 14 | 50 | 506.6 | 8 | 3940 | 4.32 |

| Device | Package Name | Package Type | Pins | SPQ | L (mm) | W (mm) | T (µm) | B (mm) |
|------------|--------------|--------------|------|-----|--------|--------|--------|--------|
| LM339ADE4 | D | SOIC | 14 | 50 | 507 | 8 | 3940 | 4.32 |
| LM339ADG4 | D | SOIC | 14 | 50 | 506.6 | 8 | 3940 | 4.32 |
| LM339ADG4 | D | SOIC | 14 | 50 | 507 | 8 | 3940 | 4.32 |
| LM339AN | N | PDIP | 14 | 25 | 506 | 13.97 | 11230 | 4.32 |
| LM339AN | N | PDIP | 14 | 25 | 506 | 13.97 | 11230 | 4.32 |
| LM339AN | N | PDIP | 14 | 25 | 506.1 | 9 | 600 | 5.4 |
| LM339ANE4 | N | PDIP | 14 | 25 | 506 | 13.97 | 11230 | 4.32 |
| LM339ANE4 | N | PDIP | 14 | 25 | 506 | 13.97 | 11230 | 4.32 |
| LM339ANE4 | N | PDIP | 14 | 25 | 506.1 | 9 | 600 | 5.4 |
| LM339APW | PW | TSSOP | 14 | 90 | 530 | 10.2 | 3600 | 3.5 |
| LM339APWG4 | PW | TSSOP | 14 | 90 | 530 | 10.2 | 3600 | 3.5 |
| LM339D | D | SOIC | 14 | 50 | 507 | 8 | 3940 | 4.32 |
| LM339D | D | SOIC | 14 | 50 | 506.6 | 8 | 3940 | 4.32 |
| LM339DE4 | D | SOIC | 14 | 50 | 507 | 8 | 3940 | 4.32 |
| LM339DE4 | D | SOIC | 14 | 50 | 506.6 | 8 | 3940 | 4.32 |
| LM339DG4 | D | SOIC | 14 | 50 | 507 | 8 | 3940 | 4.32 |
| LM339DG4 | D | SOIC | 14 | 50 | 506.6 | 8 | 3940 | 4.32 |
| LM339N | N | PDIP | 14 | 25 | 506 | 13.97 | 11230 | 4.32 |
| LM339N | N | PDIP | 14 | 25 | 506 | 13.97 | 11230 | 4.32 |
| LM339N | N | PDIP | 14 | 25 | 506.1 | 9 | 600 | 5.4 |
| LM339NE3 | N | PDIP | 14 | 25 | 506.1 | 9 | 600 | 5.4 |
| LM339NE4 | N | PDIP | 14 | 25 | 506 | 13.97 | 11230 | 4.32 |
| LM339NE4 | N | PDIP | 14 | 25 | 506 | 13.97 | 11230 | 4.32 |
| LM339PW | PW | TSSOP | 14 | 90 | 530 | 10.2 | 3600 | 3.5 |
| LM339PWG4 | PW | TSSOP | 14 | 90 | 530 | 10.2 | 3600 | 3.5 |

MECHANICAL DATA

NS (R-PDSO-G**)

PLASTIC SMALL-OUTLINE PACKAGE

14-PINS SHOWN



- NOTES:
- A. All linear dimensions are in millimeters.
 - B. This drawing is subject to change without notice.
 - C. Body dimensions do not include mold flash or protrusion, not to exceed 0,15.

D (R-PDSO-G14)

PLASTIC SMALL OUTLINE



- NOTES:
- A. All linear dimensions are in inches (millimeters).
 - B. This drawing is subject to change without notice.
 - Body length does not include mold flash, protrusions, or gate burrs. Mold flash, protrusions, or gate burrs shall not exceed 0.006 (0,15) each side.
 - Body width does not include interlead flash. Interlead flash shall not exceed 0.017 (0,43) each side.
 - E. Reference JEDEC MS-012 variation AB.

D (R-PDSO-G14)

PLASTIC SMALL OUTLINE



- NOTES:
- All linear dimensions are in millimeters.
 - This drawing is subject to change without notice.
 - Publication IPC-7351 is recommended for alternate designs.
 - Laser cutting apertures with trapezoidal walls and also rounding corners will offer better paste release. Customers should contact their board assembly site for stencil design recommendations. Refer to IPC-7525 for other stencil recommendations.
 - Customers should contact their board fabrication site for solder mask tolerances between and around signal pads.

PW (R-PDSO-G14)

PLASTIC SMALL OUTLINE



- NOTES:
- A. All linear dimensions are in millimeters. Dimensioning and tolerancing per ASME Y14.5M-1994.
 - B. This drawing is subject to change without notice.
 - C. Body length does not include mold flash, protrusions, or gate burrs. Mold flash, protrusions, or gate burrs shall not exceed 0,15 each side.
 - D. Body width does not include interlead flash. Interlead flash shall not exceed 0,25 each side.
 - E. Falls within JEDEC MO-153

PW (R-PDSO-G14)

PLASTIC SMALL OUTLINE



- NOTES:
- All linear dimensions are in millimeters.
 - This drawing is subject to change without notice.
 - Publication IPC-7351 is recommended for alternate designs.
 - Laser cutting apertures with trapezoidal walls and also rounding corners will offer better paste release. Customers should contact their board assembly site for stencil design recommendations. Refer to IPC-7525 for other stencil recommendations.
 - Customers should contact their board fabrication site for solder mask tolerances between and around signal pads.

N (R-PDIP-T**)

PLASTIC DUAL-IN-LINE PACKAGE

16 PINS SHOWN



4040049/E 12/2002

- NOTES:
- A. All linear dimensions are in inches (millimeters).
 - B. This drawing is subject to change without notice.
 - $\triangle C$ Falls within JEDEC MS-001, except 18 and 20 pin minimum body length (Dim A).
 - $\triangle D$ The 20 pin end lead shoulder width is a vendor option, either half or full width.

重要声明和免责声明

TI“按原样”提供技术和可靠性数据（包括数据表）、设计资源（包括参考设计）、应用或其他设计建议、网络工具、安全信息和其他资源，不保证没有瑕疵且不做任何明示或暗示的担保，包括但不限于对适销性、某特定用途方面的适用性或不侵犯任何第三方知识产权的暗示担保。

这些资源可供使用 TI 产品进行设计的熟练开发人员使用。您将自行承担以下全部责任：(1) 针对您的应用选择合适的 TI 产品，(2) 设计、验证并测试您的应用，(3) 确保您的应用满足相应标准以及任何其他功能安全、信息安全、监管或其他要求。

这些资源如有变更，恕不另行通知。TI 授权您仅可将这些资源用于研发本资源所述的 TI 产品的应用。严禁对这些资源进行其他复制或展示。您无权使用任何其他 TI 知识产权或任何第三方知识产权。您应全额赔偿因在这些资源的使用中对 TI 及其代表造成的任何索赔、损害、成本、损失和债务，TI 对此概不负责。

TI 提供的产品受 [TI 的销售条款](#) 或 [ti.com](#) 上其他适用条款/TI 产品随附的其他适用条款的约束。TI 提供这些资源并不会扩展或以其他方式更改 TI 针对 TI 产品发布的适用的担保或担保免责声明。

TI 反对并拒绝您可能提出的任何其他或不同的条款。

邮寄地址：Texas Instruments, Post Office Box 655303, Dallas, Texas 75265

Copyright © 2023，德州仪器 (TI) 公司